

Nut

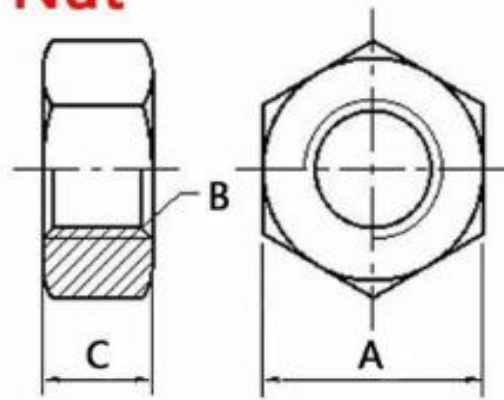

Metric Thread

Nut size	B Thread diameter	C Thick	A Wide
M3	M3 (3mm)	2.4mm	5.4mm