

CUSTOMER'S NAME

TAYDA (THAILAND) COMPANY LIMITED

ALPHA REFERENCE NO.



SP17120011

## SPECIFICATION

PART NO.	ALPHA MODEL NAME
	RV09AF-40-20K-B100K
	A-1851

MODEL NAME
MODEL NO.

APPROVAL

PREPARED BY	REVIEWED BY	APPROVED BY
 2017.12.04 彩霞	 2017.12.4. 延玲	 2017.12.4. 祖衛



台灣艾華電子工業股份有限公司

33045 桃園市桃園區中正路 1221 號 9 樓

TAIWAN ALPHA ELECTRONIC CO., LTD.

9F, No. 1221, Chung Cheng Rd., Taoyuan Dist., Taoyuan City, 330 Taiwan

Tel: 886-3-3577799

Fax: 886-3-3577700

EMAIL: sales@taiwanalpha.com.tw

URL: http://www.taiwanalpha.com

SHAFT SHOWN IN FULL C.C.W. POSITION

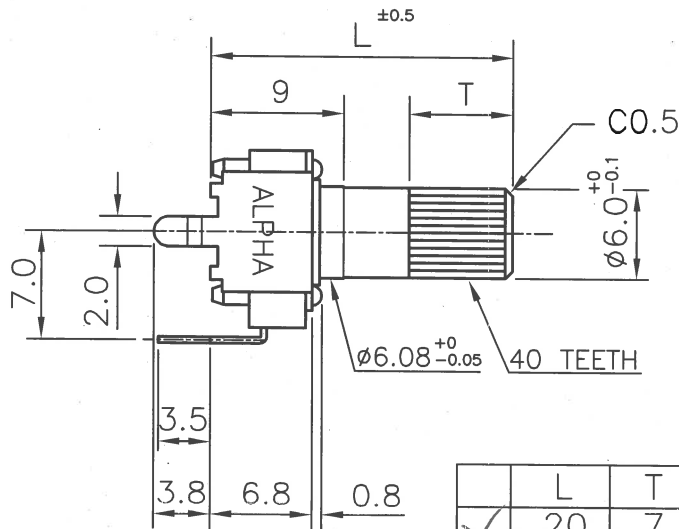

	L	T
✓	20	7
	25	7
	30	7
	175	5.5

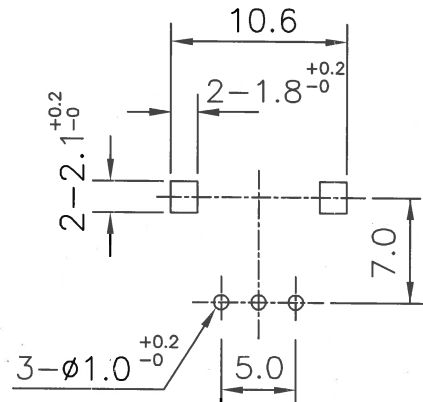
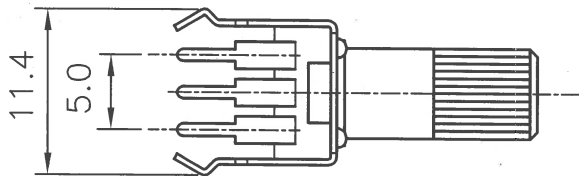
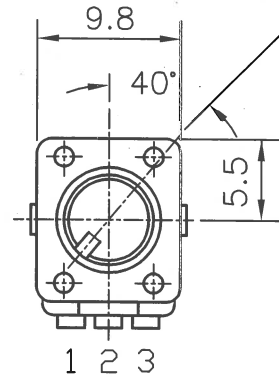

P.C.B. MOUNTING HOLE DETAIL

● — 280° ROTATION MONO UNIT

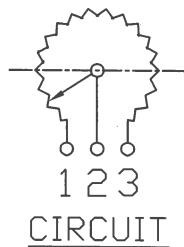

							-(0083)
							-(0042)
							RV09AF-40-(L)K-XXX-(0C)
NO.	DATE	DESCRIPTION			MODEL NAME		
TOL. UNLESS OTHERWISE STATED		DIMENSION	SCALE	DRAWN BY	CHECKED BY	APPROVED BY	DRAWING NO.
less than 10		±0.3	2:1	彭 2012.6.8 錫匯		劉 2012.6.8 全紅	
above 10 ~ 30		±0.5					
above 30 ~ 100		±1.0					
above		±5°					

## 一、Environment

- 1.1 Operating temperature range      使用溫度範圍      -10~+70°C
- 1.2 Storage temperature range      儲存溫度範圍      -25~+75°C
- 1.3 Test conditions      試驗條件  
Standard atmospheric conditions      標準狀態  
Unless otherwise specified, the standard range of atmospheric Conditions for making measurements and tests is as follows: 5~35°C, 相對溼度 45~85%, 氣壓 860~1060mbar 之標準狀態測定  
Ambient temperature: 5~35°C    Relative humidity : 45~85%  
Air pressure: 860 mbar to 1060 mbar
- If there is any doubt about the results, measurements shall be made within the following limit      發生判定疑問或另有特別要求則以基準狀態(溫度 20±2°C, 相對溼度 60~70% 氣壓 860~1060mbar)為準測定  
Ambient temperature: 20±2°C    Relative humidity : 60~70%  
Air pressure: 860 mbar to 1060 mbar

## 二、Mechanical characteristics      機械的性能

	Item 項目	Specifications 規格
1	Total rotational angle 全迴轉角度	280°±5°
2	Rotational torque 迴轉轉矩	10~100gf-cm(rotational speed 60°/1 sec.)
3	Shaft stop strength 軸迴轉止動強度	3 kgf
4	Push and pull strength of shaft 軸壓拉強度	Push and pull static load of 5 Kgf shall be applied to the shaft in the axial direction for 3 seconds. No abnormality in electric characteristics and operating feeling. 在軸壓及拉的方向加 5 Kgf 靜負荷 3 秒鐘, 作用後不會影響其電氣特性及操作感覺。

5	Starting torque 起動迴轉轉矩	10-100gf-cm
6	Shaft wobble 軸晃動	A momentary load of 250gf.cm shall be applied at the point 5mm from the tip of the shaft in a direction perpendicular to the axis of shaft, the wobble is 0.8 x L / 20 mm p-p max. (L: shaft length). 軸端前 5 mm 位置加 250gf.cm，晃動程度 0.8 x L / 20 mm p-p 以下，(L：軸長)。
7	Resistance to soldering heat 銲錫耐熱性	After soldering ,there shall be no evidence of poor contact between resistance element and terminals , or any physical damages as a result of the test 銲錫後不能發生顯著的鬆動或接觸不良
三、Electrical characteristics 電氣的性能		
	Item 項目	Specifications 規格
1	Nominal total resistance 全阻抗值許容差	Terminal 1-3      100 K $\Omega$ ±20% 1-3 端全阻值      100 K $\Omega$ ±20%
2	Rated wattage 額定功率	0.05W
3	Maximum working voltage 最大工作電壓	AC 50V , DC20V 交流 50 伏，直流 20 伏
4	Noise 摺動雜音	Refers to JIS: C 6443 Less than 100mV 依 JIS: C 6443 測定法 100 mV 以下
5	Insulation resistance 絕緣阻抗	100M $\Omega$ min at DC250 volts DC 250V 需在 100 M $\Omega$ 以上

	Item 項目	Specifications 規格		
6	阻抗變化特性 TAPER:  阻抗變化特性 TAPER	測定角度(50%) Test point(50%)	端子 1-2 間輸出電壓 V1-2 端子 1-3 間輸出電壓 V1-3 (%)	端子 2-3 間輸出電壓 V2-3 端子 1-3 間輸出電壓 V1-3 (%)
	A	140°	10-25	
	B	140°	40-60	
	C	140°		10-25
	D(10A)	140°	6-15	
	F(30A)	140	25-36	
	G(05A)	140	2-9	
	X(10C)	140		6-15
	E(25C)	140°		15-35
	K(25A)	140°	15-35	
7	Residual resistance 殘留阻值	Resistance at each end of the between terminals 1 and 2, and 2 and 3 shall be measured 摺動子在終端位置，在此時端子 1-2 間，端子 2-3 間測定之電阻值		Between 1-2 1-2 間  5Ω Max 5Ω 以下
8	Dielectric strength 耐電壓	Apply Ac 250V for 1 minute, between individual switch terminals and body/shaft, without damage to parts, arcing or breakdown etc 在開關端子與本體和軸間施以 AC 250V 耐 1 分鐘以上，沒有損傷、變形、絕緣破壞等情形		
9	V.R life 可變電阻壽命	10,000 Cycles		
10	Note 其他	Meet or exceed JIS:C 6443 Requirements. 依照 JIS:C 6443 普通及碳素可變電阻器		



## 可變電阻無鉛焊錫與保管條件共通規格書

### Common Specification of Lead-Free Soldering and Storage conditions for Potentiometers

以下焊錫條件以可變電阻置於單層 1.6mm 厚度之印刷電路板上測試為基準。

The specification below is based on testing results of 1.6mm thickness single layer printed circuit board.

#### 1. 手工焊錫條件：

For Manual Soldering：

1-1 操作溫度最高 350°C，操作時間 3 秒以內。

To be performed within 3 seconds at 350°C or below.

#### 2. 自動或半自動機台焊錫條件：

For Automated or Semi-Automated Soldering Equipments:

2-1 使用發泡式且比重 0.82 以上的助焊劑，發泡高度以印刷電路板厚度一半為標準，且助劑不能流入可變電阻基板表面及印刷電路板表面。

Flux of 0.82 specific gravity, applied by foam fluxer, shall be used. Foam head shall be limited to the height which is half thickness of printed circuit board to be soldered. No flux should be allowed to run up onto resistive element board of potentiometer and the surface of printed circuit board.

2-2 預熱時間不超過兩分鐘，焊錫接面 (即印刷電路板底) 最高預熱溫度不超過 100°C。

Regarding preheating, the entire flow duration should not exceed 2 minutes, and soldering surface temperature (undersurface of PCB) shall be settled within 100°C.

2-3 焊錫過程機台設定溫度在 260°C 以下、4 秒以內。

Solder Dipping is to be performed within 4 seconds at 260°C or below.

#### 3. 若回轉型電位器是塑膠軸且帶有檔位，請將主軸先調整至其中一個檔位或中心檔位上才可以進行焊錫作業。

For rotary potentiometer with plastic shaft which have centre detent or multiple detents, the shaft should be settled in relevant detent position prior to soldering process.

#### 4. 手工焊錫、自動或半自動機台焊錫不得超過一回。

Regardless of soldering facility and method, solder dipping or solder smearing must not be carried out more than 1 time.

註：本項焊錫溫度條件不適用於回流焊接作業設備。

Remarks: This specification is not recommended for and applicable in reflow soldering.

焊錫注意事項：

Caution for soldering:

如圖所示，請避免 PCB 上層表面有焊錫

Please avoid soldering on upper surface of

P.C.B. as shown.

#### 5. 保管條件(Storage conditions):

產品需儲存在原始的包裝,以及保持常溫

常濕、避免陽光直射、遠離任何腐蝕性氣體.

產品需盡快完全地使用完,建議最慢不要超過

交貨後 6 個月. 產品經拆封後,全部的數量都需迅速地使用完.

The products shall be stored in the original packaging and kept at room temperature and humidity, out of direct sunlight, and away from any and all corrosive gas. The products shall be completely used as soon as possible, but no longer than 6 months from the date of delivery. Once product packaging is opened, the complete quantity of such products shall be promptly used.

