

M9*P0.75

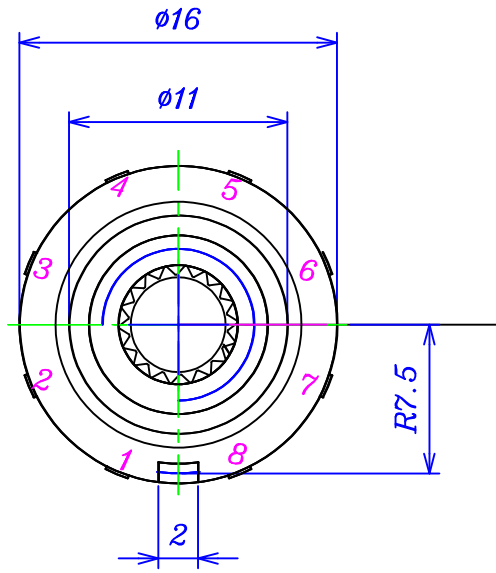

Shaft shown in full CCW position

10- $\phi 1^{+0.1}_{-0}$ Holes

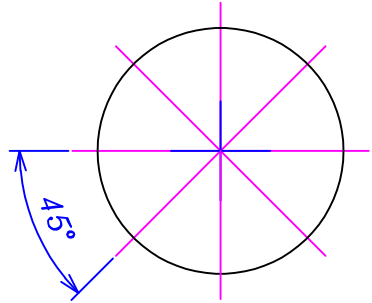
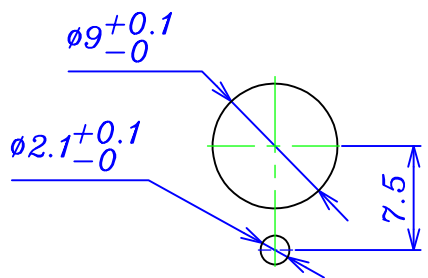
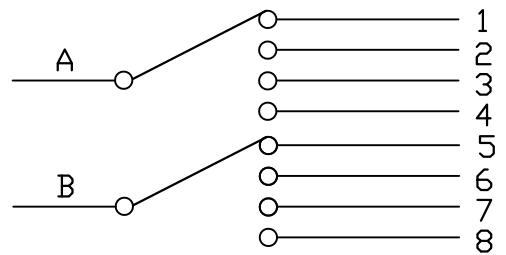

Changeover angle

Center of shaft

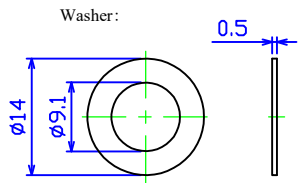
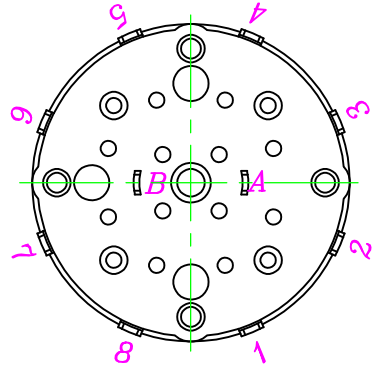
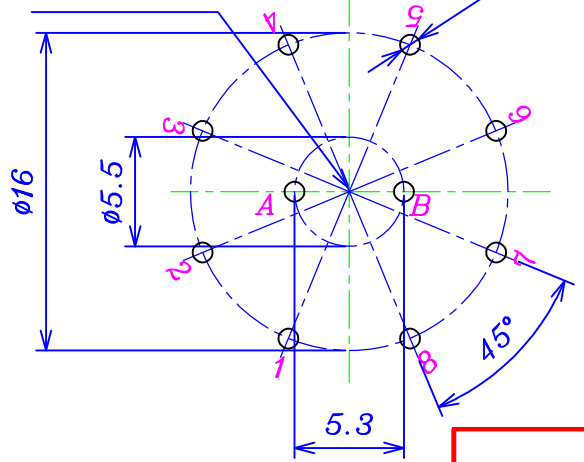

Washer:

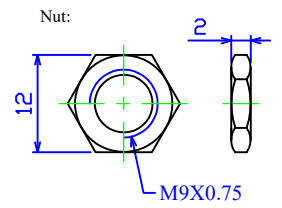

Nut:

未注尺寸公差	
L ≤ 1.0吋	±0.1
1.0 < L ≤ 10吋	±0.3
10 < L ≤ 30吋	±0.5
30 < L ≤ 100吋	±1.0

比例	2.5:1	版本	1.0	设计	审核	批准
品名	RS16211-24-TB20B12 外型图					
图号						