

Nut

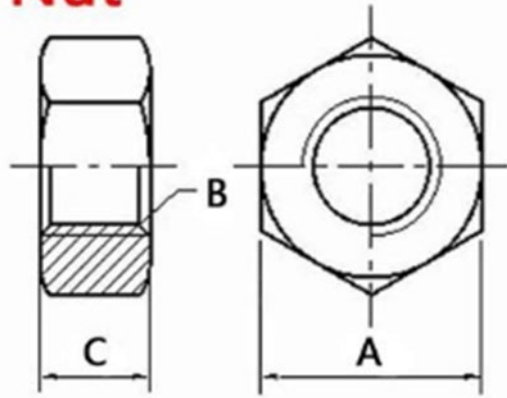

Metric Thread

Nut size	B Thread diameter	C Thick	A Wide
M4	M4 (4mm)	3.1mm	6.8 ± 0.2mm