

2M Series

Sub-Miniature Toggle Switches

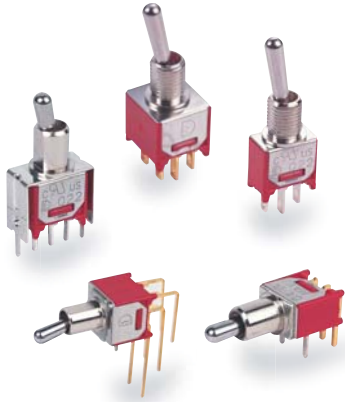

2M Toggle Switches



SPECIFICATIONS

CONTACT RATING: Dependent upon contact material See Page 29.

MECHANICAL LIFE: 30,000 make-and-break cycles.

CONTACT RESISTANCE: 20 mΩ max. initial @ 2-4VDC
100mA for both silver and gold plated contacts.

INSULATION RESISTANCE: 1,000 MΩ min.

DIELECTRIC STRENGTH: 1,000 Vrms min. @ sea level.

OPERATING TEMPERATURE: -40°C to 85°C.

MATERIALS

CASE: Diallyl phthalate (DAP) (UL94v-0).

ACTUATOR: Brass, chrome plated.

BUSHING: Brass or zinc, nickel plated.

HOUSING: Stainless Steel.

SWITCH SUPPORT: Brass, tin plated.

TERMINAL/CONTACT: Brass or copper alloy, with Silver or gold plated. (See Page 29)

HOW TO ORDER

MODEL NO. ACTUATOR BUSHING TERMINATIONS TERMINAL PLATING SEAL RoHS SOLDERING



Model NO.

- 2MS1 SP ON-NONE-ON
- 2MS2 SP ON-NONE-(ON)
- 2MS3 SP ON-OFF-ON
- 2MS4 SP (ON)-OFF-(ON)
- 2MS5 SP ON-OFF-(ON)
- 2MS6 SP OFF-NONE-ON
- 2MD1 DP ON-NONE-ON
- 2MD2 DP ON-NONE-(ON)
- 2MD3 DP ON-OFF-ON
- 2MD6 DP ON- ON -ON.

Actuator

- T1 9.40 high
- T2 5.33 high
- T3 7.37 high
- T4 10.41 high
- T5 5.59 high
- TL1 Locking lever 16.00 high
- TL2 Locking lever 16.26 high

Bushing

- B1 5.59 high, flat (thd)
- B2 5.59 high, flat (non-thd)
- B3 5.59 high, keyway (thd)
- B4 5.59 high, keyway (non-thd)
- B5 7.87 high, flat (thd)
- B6 7.87 high, flat (non-thd)
- B7 6.60 high, keyway (thd)
- B8 6.60 high, keyway (non-thd)
- B25 8.00 high, keyway, locking lever (thd)

Terminations

- M1 Solder Lug
- M2 PC thru-hole
- M51 15.24 high, wire wrap
- M52 6.00 high, wire wrap
- M6 Right angle, PC thru-hole
- M6N Right angle, snap-in, PC thru-hole
- M7 Vertical right angle, PC thru-hole
- M7N Vertical right angle, snap-in, PC thru-hole
- VS2 V-bracket
- V2N Snap-in V-bracket
- VS3 V-bracket
- V3N Snap-in V-bracket

* 2MS6 model type not applicable to M6/M6N/M7/M7N terminations

Terminal plating

- Q Silver
- R Gold
- C Gold over silver

Seal

- E EPOXY (std)
- N NO EPOXY

RoHS soldering

- S RoHS & Lead Free

SWITCH FUNCTION

NO. POLES	UL/CSA MODEL NO.	MODEL NO.	SWITCH FUNCTION			CONNECTED TERMINALS / SCHEMATIC			
			POS.1	POS.2	POS.3	POS.1	POS.2	POS.3	
SP	Q2211	2MS1	ON	NONE	ON	2-3	N/A	2-1	
	Q2212	2MS2	ON	NONE	(ON)			OPEN	
	Q2213	2MS3	ON	OFF	ON	OPEN		N/A	3-1
	Q2214	2MS4	(ON)	OFF	(ON)				
	Q2215	2MS5	ON	OFF	(ON)				
	Q2216	2MS6	OFF	NONE	ON	OPEN	N/A	3-1	
DP	Q2221	2MD1	ON	NONE	ON	2-3,5-6	N/A	2-1,5-4	
	Q2222	2MD2	ON	NONE	(ON)			OPEN	
	Q2223	2MD3	ON	OFF	ON	2-3,5-6		2-3,5-4	2-1,5-4
	Q2226	2MD6	ON	ON	ON				

()=MOMENTARY

▲ Please check the availability in advance before order

POLE OPTIONS

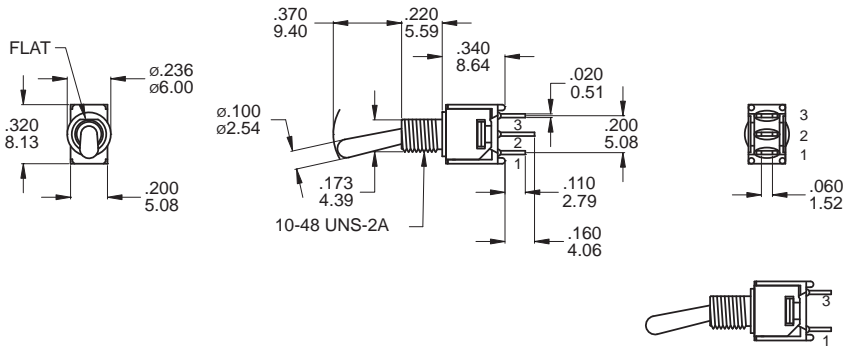

2MS6 Models : Omit 2nd terminal

SPDT

Part No. Shown : 2MS1T1B1M1QES

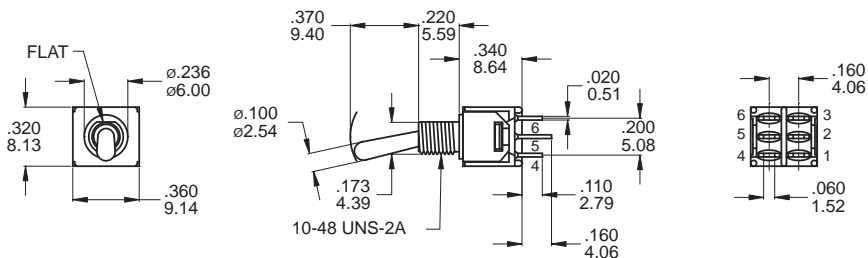

DPDT

Part No. Shown : 2MD1T1B1M1RES

2M Series

Sub-Miniature Toggle Switches

ACTUATOR OPTIONS

T1

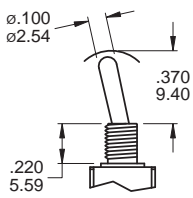

T2

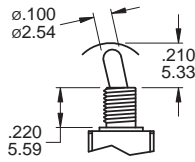

T3

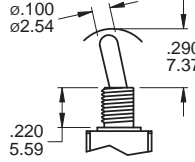

T4

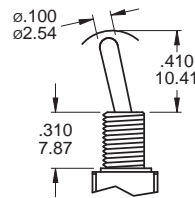

T5

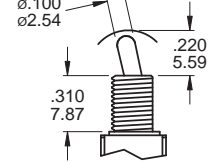

NONE: T1,T2,T3 Actuator shown with B1 to B4 bushing, subtract 0.09 (2.29) for B5 bushing, subtract 0.04 (1.02) for B7 bushing.
 T4,T5 Actuator shown with B5,B6 bushing, add 0.09 (2.29) for B1 to B3 bushing, add 0.05 (1.27) for B7 bushing.
 Std for M1,M2 Terminal sub .016(.040) for M6,M7,VSX

TL1B25

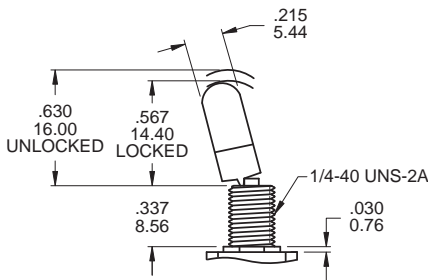

TL2B25

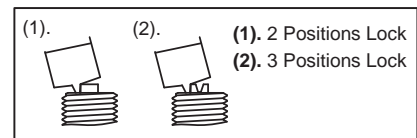
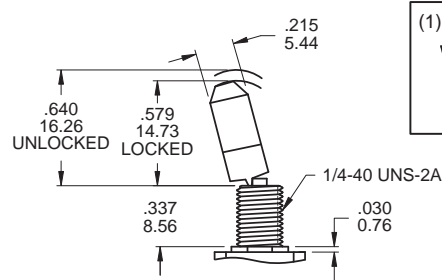

BUSHING OPTIONS

B1 THD
B2 NON-THD

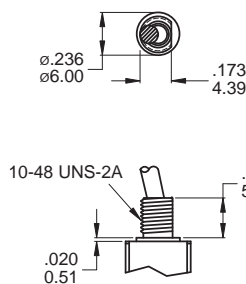

B3 THD
B4 NON-THD

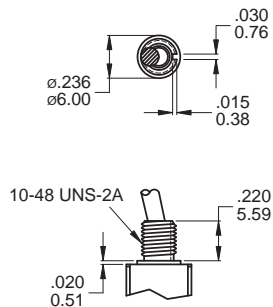

B5 THD
B6 NON-THD

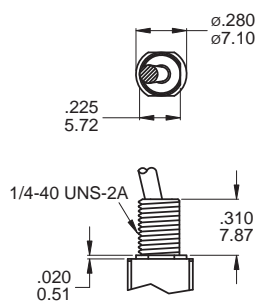

B7 THD
B8 NON-THD

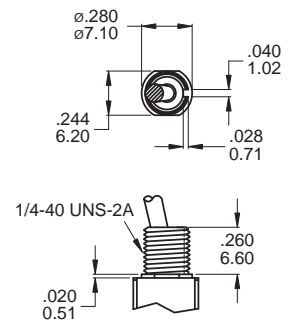

TERMINATION OPTIONS

M1 Solder lug

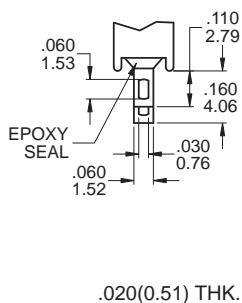

M2 PC Thru-hole

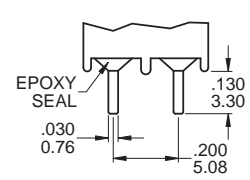
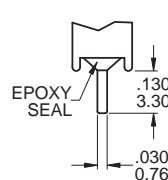
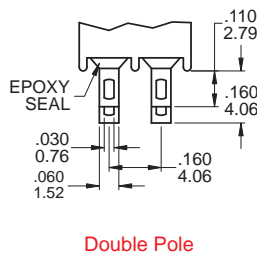

Double Pole

Double Pole

.020(0.51) THK.

.020(0.51) THK.

2M Toggle Switches

M51 Wire Wrap

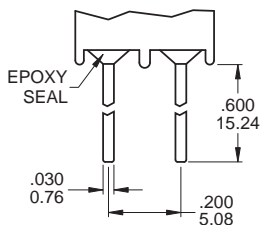
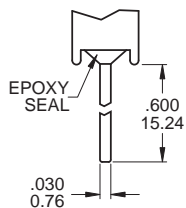

Double Pole

.020(0.51) THK.

M52 Wire Wrap

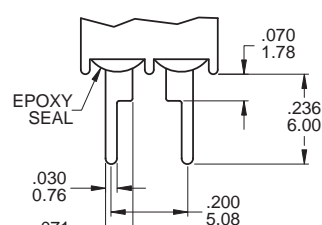
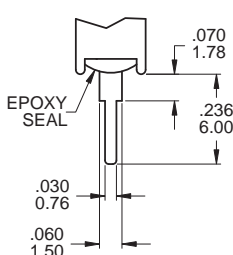

Double Pole

.020(0.51) THK.



2M
Toggle Switches

M6

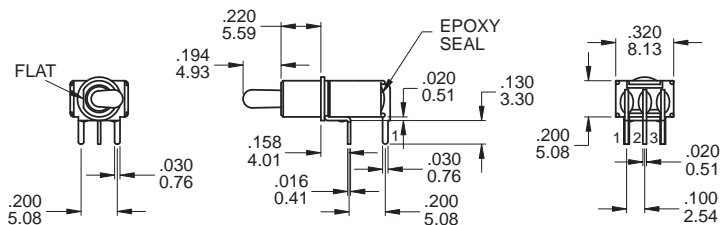

P.C. MOUNTING

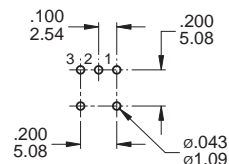

SPDT

Part No. Shown : 2MS1T2B2M6RES

M6

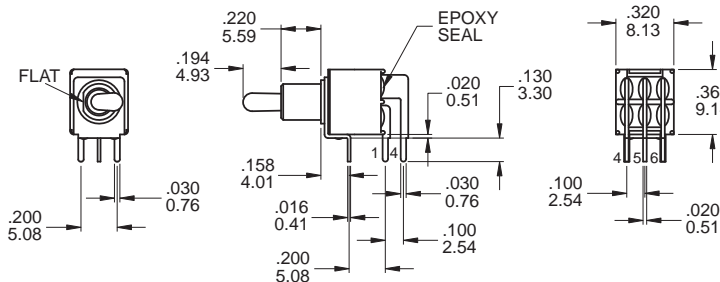
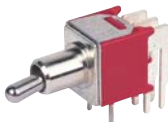

P.C. MOUNTING

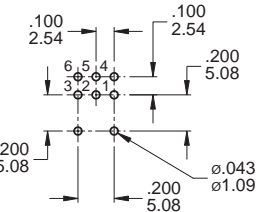

DPDT

Part No. Shown : 2MD1T2B2M6QES

M7

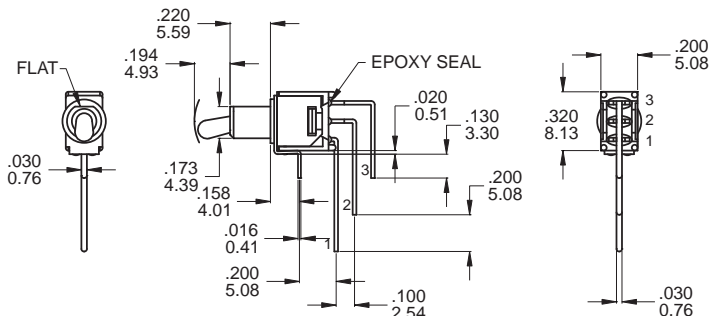

P.C. MOUNTING

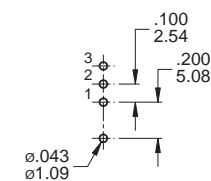

SPDT

Part No. Shown : 2MS1T2B2M7RES

2M Series

Sub-Miniature Toggle Switches

2M
Toggle Switches

M7

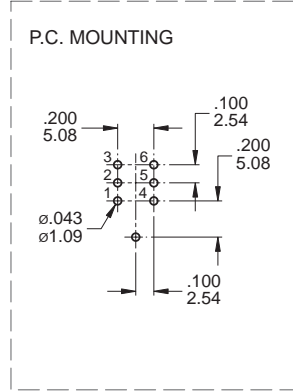
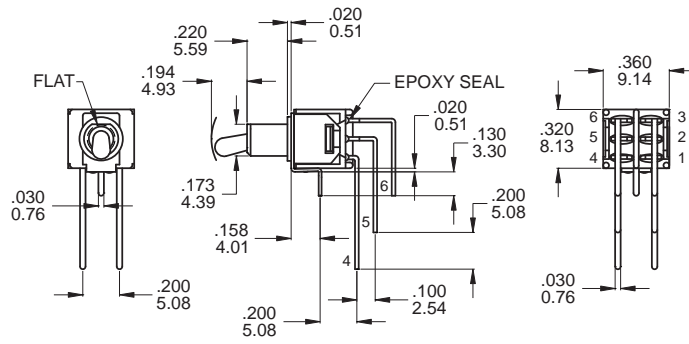
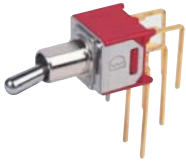

DPDT

Part No. Shown : 2MD1T2B2M7RES

VS2 - VS3

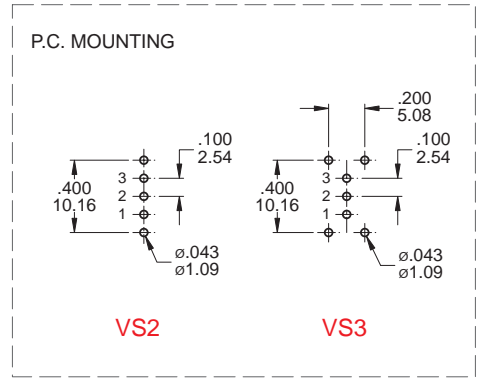
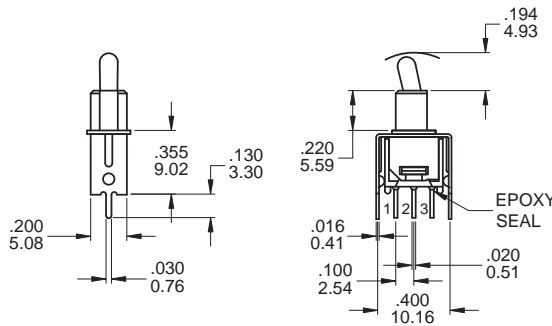

SPDT

Part No. Shown : 2MS1T2B2VS2QES

VS2 - VS3

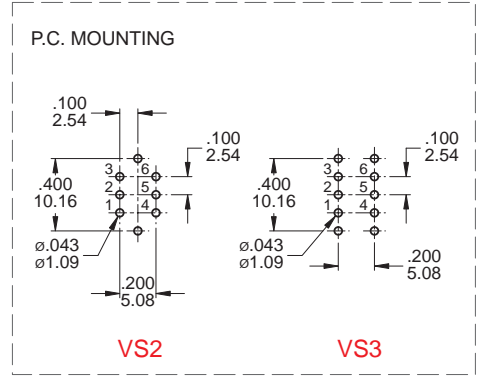
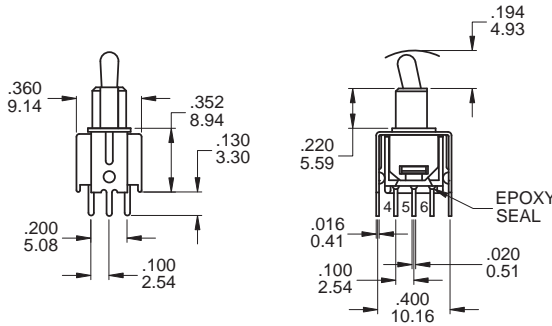

DPDT

Part No. Shown : 2MD1T2B2VS2QES

SNAP-IN TERMINATION OPTIONS

M6N

M7N

V2N

V3N

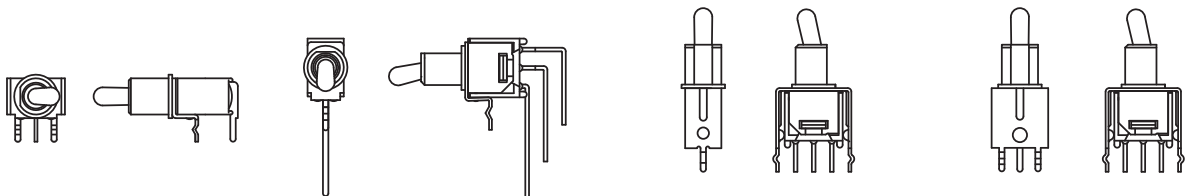

PANEL MOUNTING

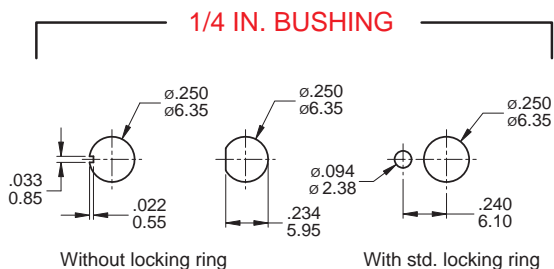
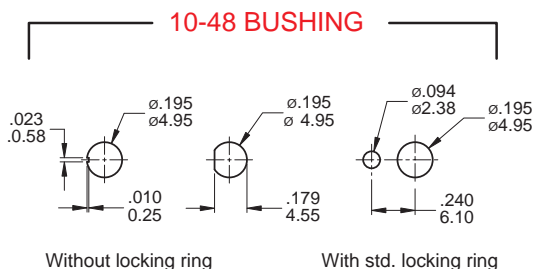

HARDWARE

10-48 NUT

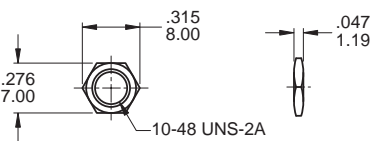

MNU-2M01

Supplied standard with B1/ B3 bushing

LOCKWASHER

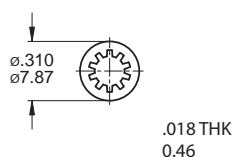

MNU-2M03

Supplied standard with B1 / B3 bushing

LOCKWASHER

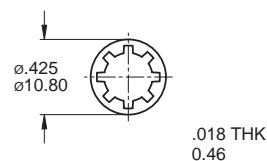

MNU-1M03

Supplied standard with B5 / B7 bushing

1/4 NUT

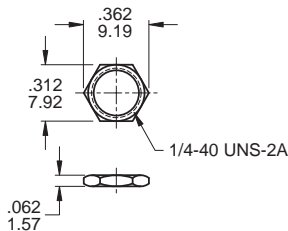

MNU-1M01A

Supplied standard with B5/ B7 bushing

LOCKING RING

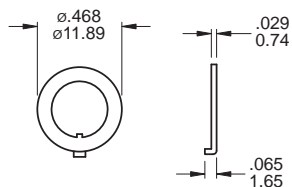

MNU-1M02

Supplied standard with B7 bushing

LOCKING RING

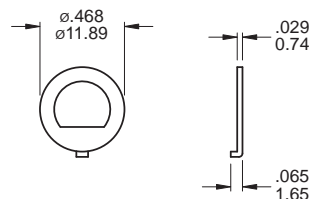

MNU-1M11

Supplied standard with B5 bushing

CONTACT MATERIAL OPTIONS

	CONTACT PLATING	TERMINAL PLATING	RATINGS
Q	Silver	Silver	3 Amps with resistant load @ 120VAC or 28VDC 1 Amps with resistant load @ 250VAC
C	Gold over Silver	Gold over silver	
R	Gold	Gold	0.4 Volt - Amps (VA) max. @ 20V max. (AC or DC)

SOLDERING PROCESSES

MANUAL SOLDERING: Use soldering iron of 30 watts, controlled at 350°C approximately 5 seconds while applying solder.

WAVE SOLDERING: Recommended Soldering Temperature: 270 ± 5°C

Duration of Solder Immersion: Max 5 sec. (PCB is 1.6mm in thickness)



2M
Toggle Switches