



HRS1 Relay



No.1426410



E164730



CQC03001008747

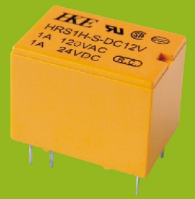

1. COIL DATA

1-1.Nominal Voltage	3,5,6,9,12,24VDC
1-2.Coil Resistance	Refer to CoilData Chart
1-3.Operate Voltage	Refer to CoilData Chart
1-4.Release Voltage	Refer to CoilData Chart
1-5.Coil Power	200mW、360mW

2. CONTACT DATA

2-1.Contact Form	C-1 form C
2-2.Contact Material	AuAg overlay,Ag Alloy
2-3.Contact Rating	1A 120VAC/24VDC
2-4.Max.Switching Voltage	220VAC/30VDC
2-5.Max.Switching Current	2A
2-6.Max.Switching Power	120VA,30W
2-7.Min.Switching Load	5VDC,10mA
2-8.Contact Resistance	Max.50mΩ (6VDC 0.1A)
2-9.Life	
Electrical	100,000 operations
Mechanical	10,000,000 operations

3. GENERAL DATA

3-1.Insulation Resistance	Min.100MΩ 500VDC
3-2.Dielectric Strength	750VAC,1min between open contacts 1,000VAC,1min between coil and contacts
3-3.Operate Time	Max.5ms
3-4.Release Time	Max.5ms
3-5.Operate Temperature	-25 ~+70°C
3-6.Shock Resistance	
Endurance	1,000m/s ²
Misoperation	100m/s ²
3-7.Vibration Resistance	
Endurance	10 -55Hz,1.5mm double amplitude
Misoperation	10 -55Hz,1.5mm double amplitude
3-8.Humidity	35~95%RH,+40°C
3-9.Weight	Approximately4.0g
3-10.Safety	UL NO.E164730 CSA NO.1426410 CQC NO.03001008747



HRS1 Relay



No.1426410



E164730



CQC03001008747

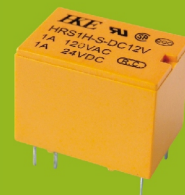

4. ORDER CODE

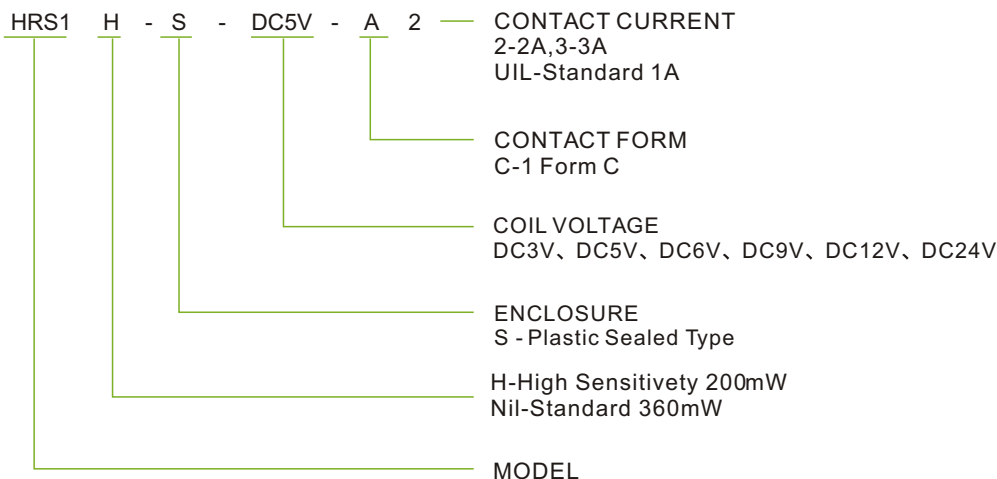

5.COIL DATA CHART

20°C

Model	Nominal Voltage VDC	Coil Resistance $\Omega \pm 10\%$	Operate Voltage \leq VDC	Release Voltage \geq VDC	Coil Power mW
HRS1(S)-DC3V	3	25	2.1	0.30	360
HRS1(S)-DC5V	5	70	3.5	0.50	
HRS1(S)-DC6V	6	100	4.2	0.60	
HRS1(S)-DC9V	9	225	6.3	0.90	
HRS1(S)-DC12V	12	400	8.4	1.20	
HRS1(S)-DC24V	24	1600	16.8	2.40	
HRS1H(S)-DC3V	3	45	2.25	0.30	200
HRS1H(S)-DC5V	5	125	3.75	0.50	
HRS1H(S)-DC6V	6	180	4.5	0.60	
HRS1H(S)-DC9V	9	405	6.75	0.90	
HRS1H(S)-DC12V	12	720	9.0	1.20	
HRS1H(S)-DC24V	24	2880	18.0	2.40	

6.DIMENSIONS(mm)

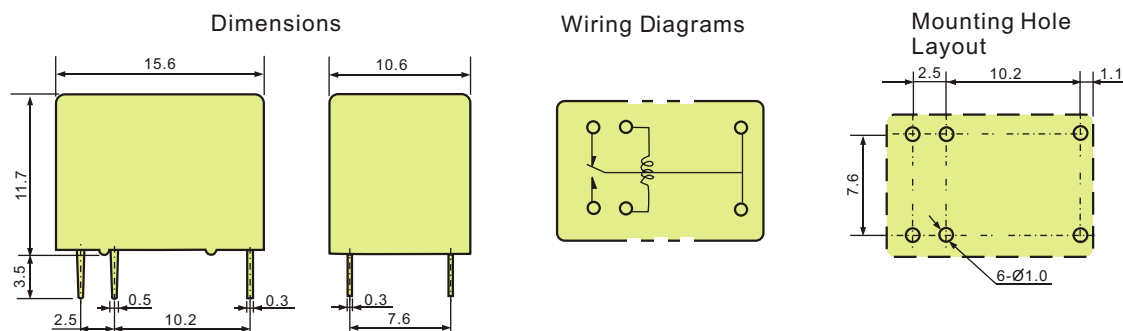

7.HRS1 CHARACTERISTIC CHART DAT

Timing

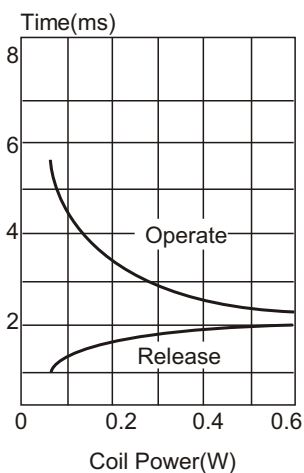

Coil Temperature Rise

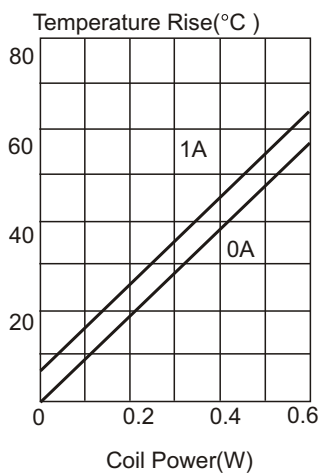

Operate Range

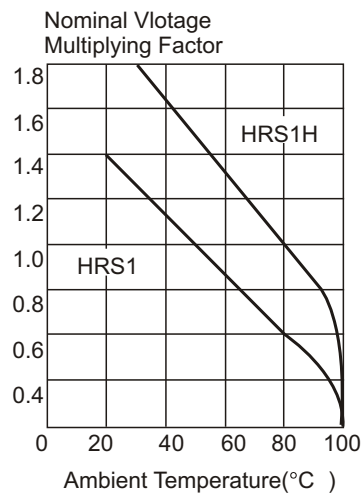

Max.Switching Power

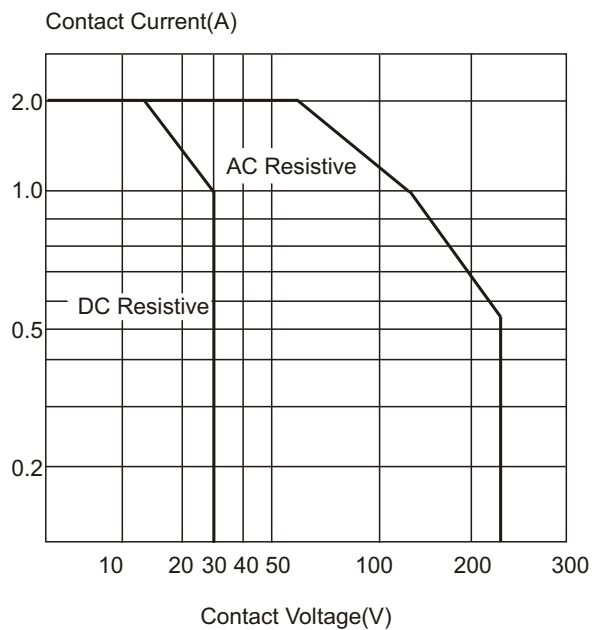

Life Curves

