

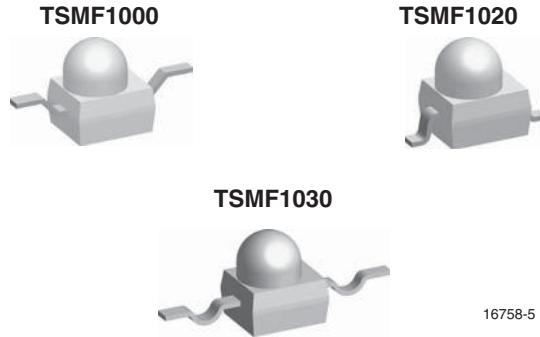

## High Speed Infrared Emitting Diode, RoHS Compliant, 890 nm, GaAlAs Double Hetero



### FEATURES

- Package type: surface mount
- Package form: GW, RGW, yoke, axial
- Dimensions (L x W x H in mm): 2.5 x 2 x 2.7
- Peak wavelength:  $\lambda_p = 890 \text{ nm}$
- High radiant power
- Angle of half intensity:  $\phi = \pm 17^\circ$
- Low forward voltage
- Suitable for high pulse current operation
- Versatile terminal configurations
- Package matches with detector TEMD1000
- Floor life: 168 h, MSL 3, acc. J-STD-020
- Compliant to RoHS Directive 2002/95/EC and in accordance with WEEE 2002/96/EC



RoHS COMPLIANT

### DESCRIPTION

TSMF1000 series are infrared, 890 nm emitting diodes in GaAlAs double hetero (DH) technology with high radiant power and high speed, molded in clear, untinted plastic packages (with lens) for surface mounting (SMD).

### APPLICATIONS

- IrDA compatible data transmission
- Miniature light barrier
- Photointerrupters
- Optical switch
- Control and drive circuits
- Shaft encoders

PRODUCT SUMMARY				
COMPONENT	$I_e$ (mW/sr)	$\phi$ (deg)	$\lambda_p$ (nm)	$t_r$ (ns)
TSMF1000	5	$\pm 17$	890	30
TSMF1020	5	$\pm 17$	890	30
TSMF1030	5	$\pm 17$	890	30

#### Note

- Test conditions see table "Basic Characteristics"

ORDERING INFORMATION			
ORDERING CODE	PACKAGING	REMARKS	PACKAGE FORM
TSMF1000	Tape and reel	MOQ: 1000 pcs, 1000 pcs/reel	Reverse gullwing
TSMF1020	Tape and reel	MOQ: 1000 pcs, 1000 pcs/reel	Gullwing
TSMF1030	Tape and reel	MOQ: 1000 pcs, 1000 pcs/reel	Yoke

#### Note

- MOQ: minimum order quantity



<b>ABSOLUTE MAXIMUM RATINGS</b> ( $T_{amb} = 25\text{ }^{\circ}\text{C}$ , unless otherwise specified)				
PARAMETER	TEST CONDITION	SYMBOL	VALUE	UNIT
Reverse voltage		$V_R$	5	V
Forward current		$I_F$	100	mA
Peak forward current	$t_p/T = 0.5$ , $t_p = 100\text{ }\mu\text{s}$	$I_{FM}$	200	mA
Surge forward current	$t_p = 100\text{ }\mu\text{s}$	$I_{FSM}$	0.8	A
Power dissipation		$P_V$	180	mW
Junction temperature		$T_j$	100	$^{\circ}\text{C}$
Operating temperature range		$T_{amb}$	- 40 to + 85	$^{\circ}\text{C}$
Storage temperature range		$T_{stg}$	- 40 to + 100	$^{\circ}\text{C}$
Soldering temperature	$t \leq 5\text{ s}$	$T_{sd}$	260	$^{\circ}\text{C}$
Thermal resistance junction/ambient	Soldered on PCB, pad dimensions: 4 mm x 4 mm	$R_{thJA}$	400	K/W

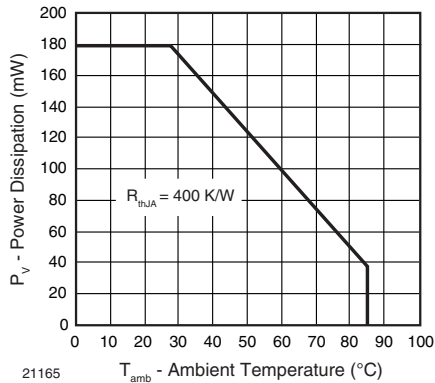

Fig. 1 - Power Dissipation Limit vs. Ambient Temperature

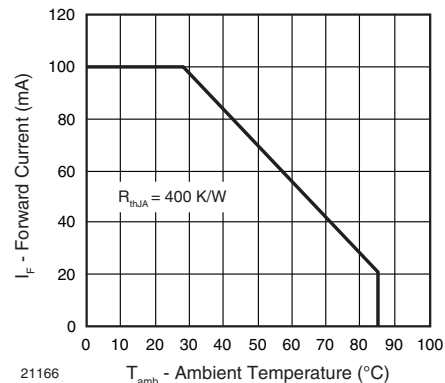

Fig. 2 - Forward Current Limit vs. Ambient Temperature

<b>BASIC CHARACTERISTICS</b> ( $T_{amb} = 25\text{ }^{\circ}\text{C}$ , unless otherwise specified)						
PARAMETER	TEST CONDITION	SYMBOL	MIN.	TYP.	MAX.	UNIT
Forward voltage	$I_F = 20\text{ mA}$	$V_F$		1.3	1.5	V
	$I_F = 1\text{ A}$ , $t_p = 100\text{ }\mu\text{s}$	$V_F$		2.4		V
Temperature coefficient of $V_F$	$I_F = 1\text{ mA}$	$TK_{V_F}$		- 1.8		mV/K
Reverse current	$V_R = 5\text{ V}$	$I_R$			10	$\mu\text{A}$
Junction capacitance	$V_R = 0\text{ V}$ , $f = 1\text{ MHz}$ , $E = 0$	$C_j$		160		pF
Radiant intensity	$I_F = 20\text{ mA}$	$I_e$	2.5	5	13	mW/sr
	$I_F = 100\text{ mA}$ , $t_p = 100\text{ }\mu\text{s}$	$I_e$		25		mW/sr
Radiant power	$I_F = 100\text{ mA}$ , $t_p = 20\text{ ms}$	$\phi_e$		35		mW
Temperature coefficient of $\phi_e$	$I_F = 20\text{ mA}$	$TK_{\phi_e}$		- 0.6		%/K
Angle of half intensity		$\varphi$		$\pm 17$		deg
Peak wavelength	$I_F = 20\text{ mA}$	$\lambda_p$		890		nm
Spectral bandwidth	$I_F = 20\text{ mA}$	$\Delta\lambda$		40		nm
Temperature coefficient of $\lambda_p$	$I_F = 20\text{ mA}$	$TK_{\lambda_p}$		0.2		nm/K
Rise time	$I_F = 20\text{ mA}$	$t_r$		30		ns
Fall time	$I_F = 20\text{ mA}$	$t_f$		30		ns
Cut-off frequency	$I_{DC} = 70\text{ mA}$ , $I_{AC} = 30\text{ mA pp}$	$f_c$		12		MHz
Virtual source diameter		$d$		1.2		mm

**BASIC CHARACTERISTICS** ( $T_{amb} = 25\text{ }^{\circ}\text{C}$ , unless otherwise specified)

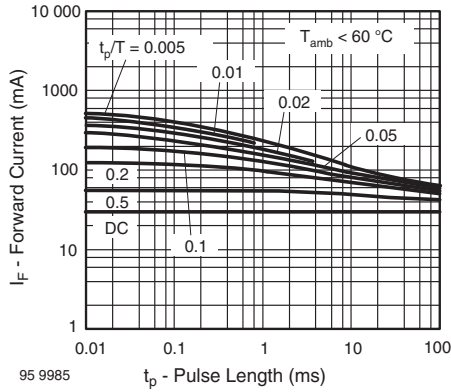

Fig. 3 - Pulse Forward Current vs. Pulse Duration

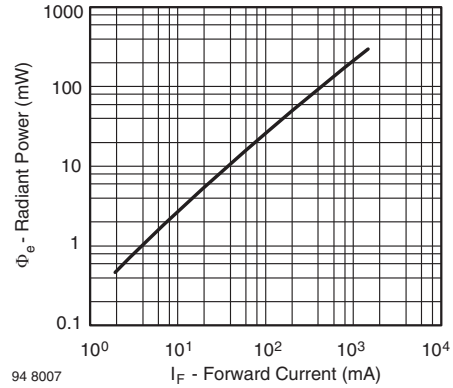

Fig. 6 - Radiant Power vs. Forward Current

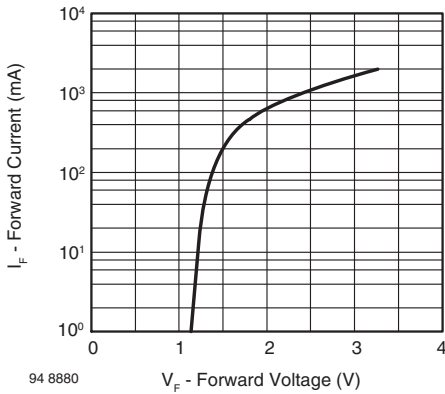

Fig. 4 - Forward Current vs. Forward Voltage

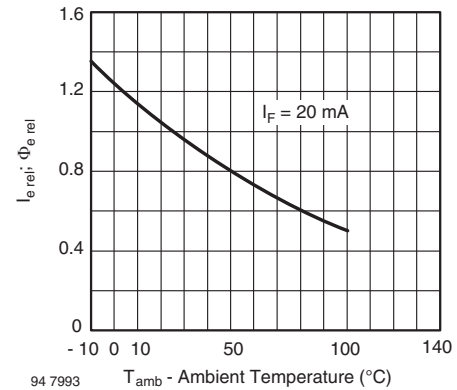

Fig. 7 - Rel. Radiant Intensity/Power vs. Ambient Temperature

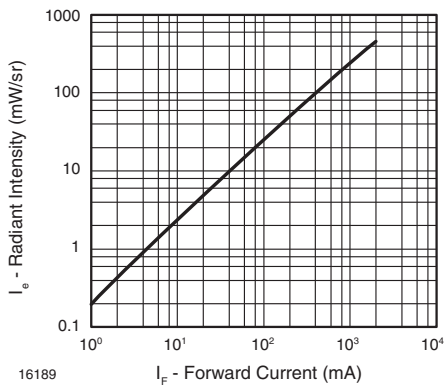

Fig. 5 - Radiant Intensity vs. Forward Current

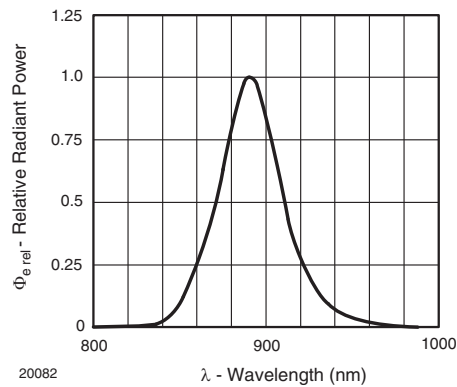

Fig. 8 - Relative Radiant Power vs. Wavelength

**REFLOW SOLDER PROFILE**

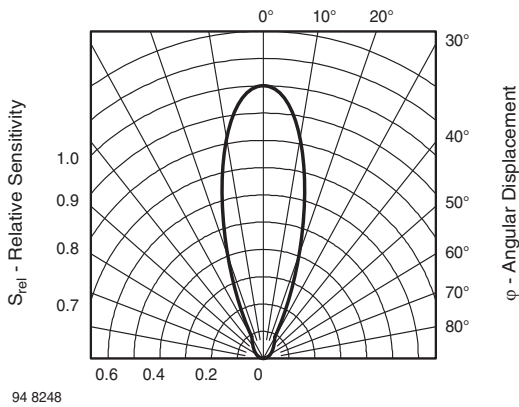

Fig. 9 - Relative Radiant Intensity vs. Angular Displacement

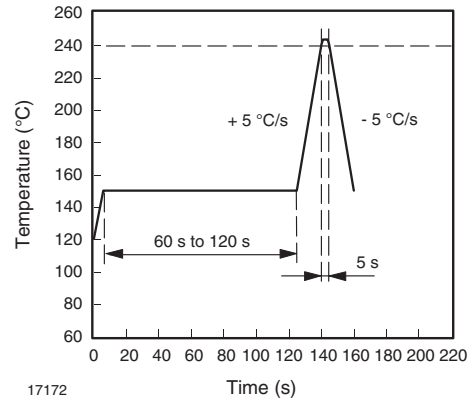

Fig. 10 - Lead Tin (SnPb) Reflow Solder Profile

**PRECAUTIONS FOR USE**

**1. Over-current-proof**

Customer must apply resistors for protection, otherwise slight voltage shift will cause big current change (burn out will happen).

**2. Storage**

- Storage temperature and rel. humidity conditions are: 5 °C to 35 °C, R.H. 60 %.
- Floor life must not exceed 168 h, acc. to JEDEC level 3, J-STD-020.  
Once the package is opened, the products should be used within a week. Otherwise, they should be kept in a damp proof box with desiccant. Considering tape life, we suggest to use products within one year from production date.
- If opened more than one week in an atmosphere 5 °C to 35 °C, R.H. 60 %, devices should be treated at 60 °C ± 5 °C for 15 h.
- If humidity indicator in the package shows pink color (normal blue), then devices should be treated with the same conditions as 2.3.

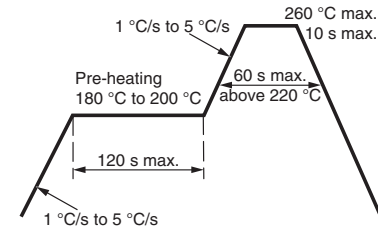

22566

Fig. 11 - Lead (Pb)-Free Reflow Solder Profile acc. J-STD-020





## PACKAGE DIMENSIONS in millimeters: TSMF1030

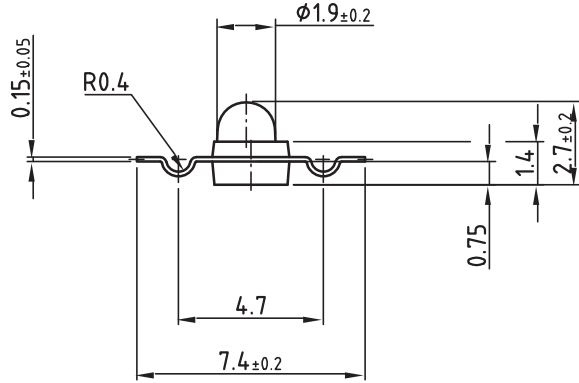

Drawing-No.: 6.544-5329.01-4

Issue: 4; 08.05.03

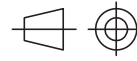

technical drawings according to DIN specifications

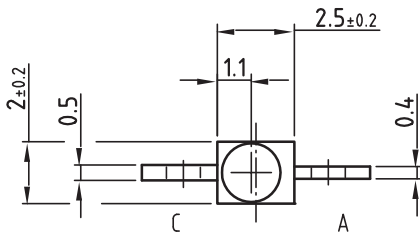

Solder pad proposal

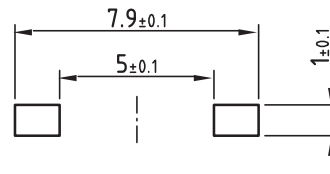

16228

## REEL DIMENSIONS in millimeters

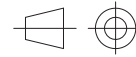
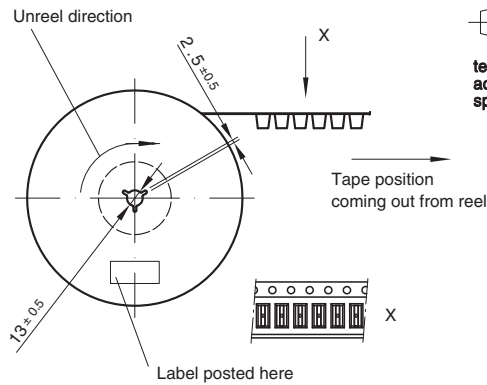
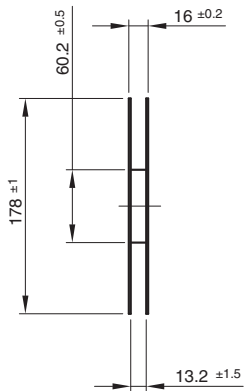

technical drawings according to DIN specifications

Leader and trailer tape:

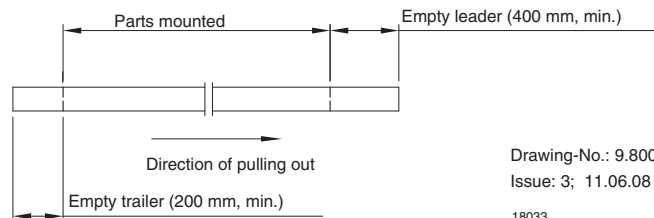

Drawing-No.: 9.800-5080.01-4

Issue: 3; 11.06.08

18033



## TAPING DIMENSIONS in millimeters: TSMF1000

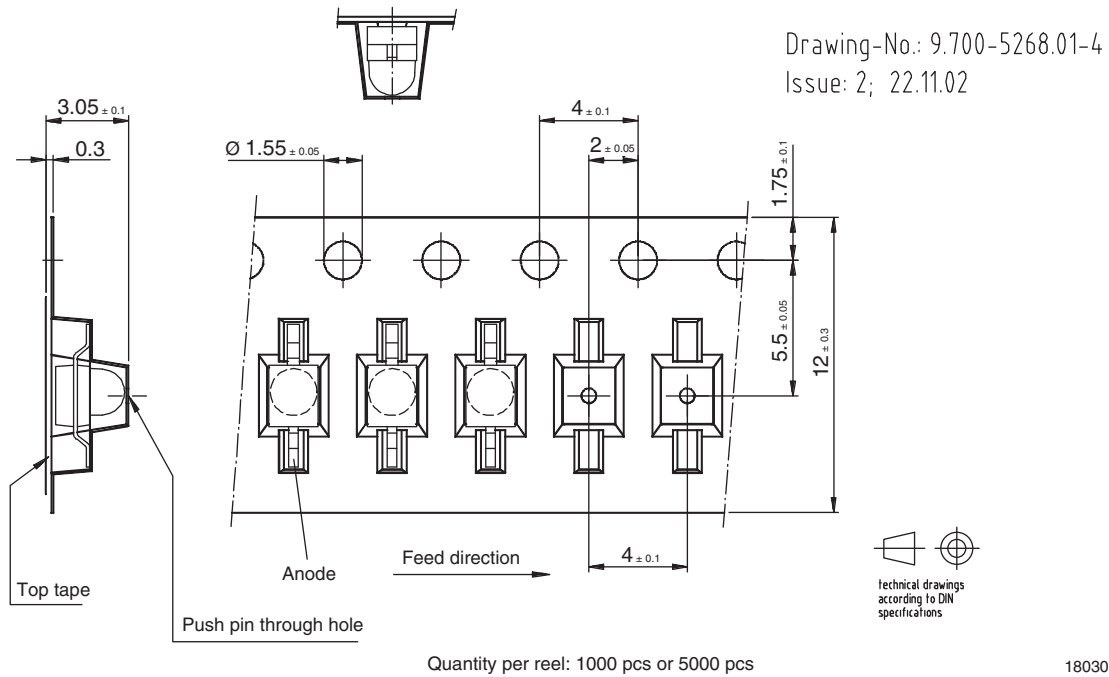

## TAPING DIMENSIONS in millimeters: TSMF1020

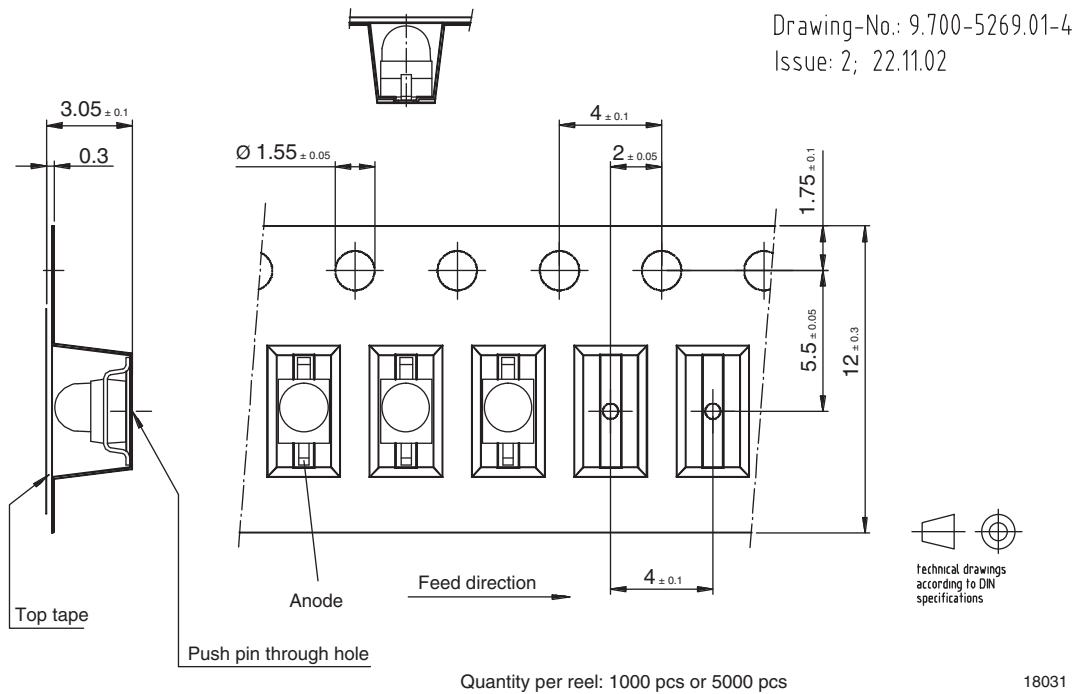



## TAPING DIMENSIONS in millimeters: TSMF1030

Drawing-No.: 9.700-5270.01-4

Issue: 2; 22.11.02

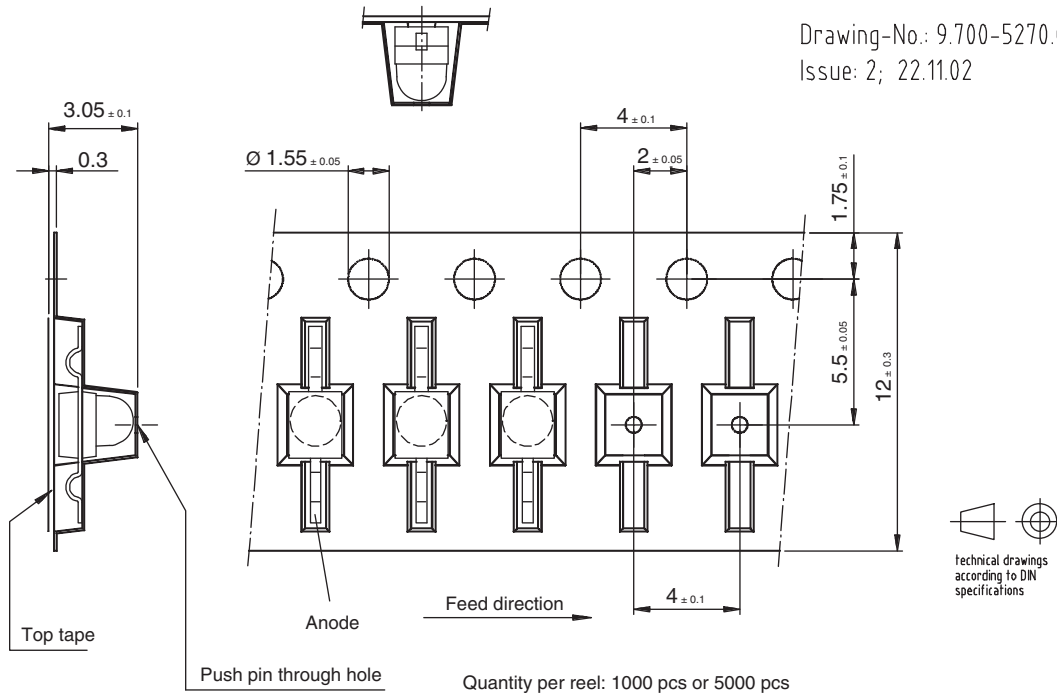

18032





## **Disclaimer**

ALL PRODUCT, PRODUCT SPECIFICATIONS AND DATA ARE SUBJECT TO CHANGE WITHOUT NOTICE TO IMPROVE RELIABILITY, FUNCTION OR DESIGN OR OTHERWISE.

Vishay Intertechnology, Inc., its affiliates, agents, and employees, and all persons acting on its or their behalf (collectively, "Vishay"), disclaim any and all liability for any errors, inaccuracies or incompleteness contained in any datasheet or in any other disclosure relating to any product.

Vishay makes no warranty, representation or guarantee regarding the suitability of the products for any particular purpose or the continuing production of any product. To the maximum extent permitted by applicable law, Vishay disclaims (i) any and all liability arising out of the application or use of any product, (ii) any and all liability, including without limitation special, consequential or incidental damages, and (iii) any and all implied warranties, including warranties of fitness for particular purpose, non-infringement and merchantability.

Statements regarding the suitability of products for certain types of applications are based on Vishay's knowledge of typical requirements that are often placed on Vishay products in generic applications. Such statements are not binding statements about the suitability of products for a particular application. It is the customer's responsibility to validate that a particular product with the properties described in the product specification is suitable for use in a particular application. Parameters provided in datasheets and / or specifications may vary in different applications and performance may vary over time. All operating parameters, including typical parameters, must be validated for each customer application by the customer's technical experts. Product specifications do not expand or otherwise modify Vishay's terms and conditions of purchase, including but not limited to the warranty expressed therein.

Except as expressly indicated in writing, Vishay products are not designed for use in medical, life-saving, or life-sustaining applications or for any other application in which the failure of the Vishay product could result in personal injury or death. Customers using or selling Vishay products not expressly indicated for use in such applications do so at their own risk. Please contact authorized Vishay personnel to obtain written terms and conditions regarding products designed for such applications.

No license, express or implied, by estoppel or otherwise, to any intellectual property rights is granted by this document or by any conduct of Vishay. Product names and markings noted herein may be trademarks of their respective owners.