

PUSH
1-2 ON

FREE
2-3 ON

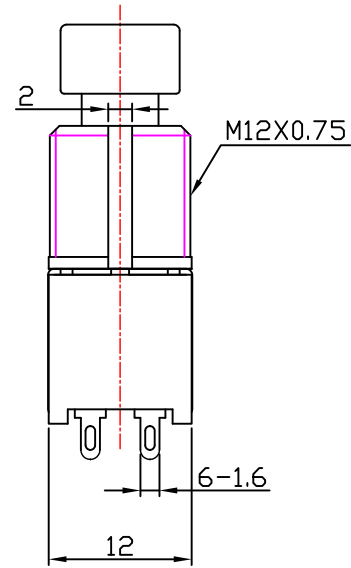
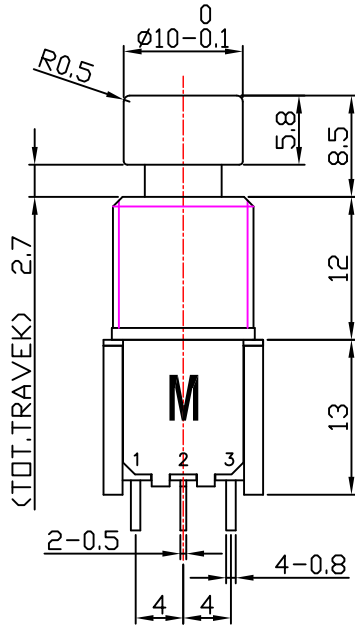

Fittings:

Cu NUT ___PCS Zn NUT ___PCS WASHER ___PCS 20TEETH WASHER ___PCS PA66 WASHER ___PCS SPRING WASHER ___PCS

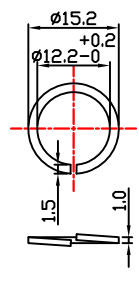
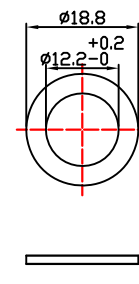
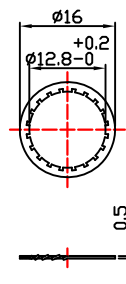
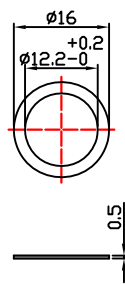
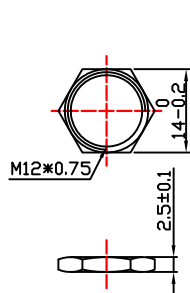
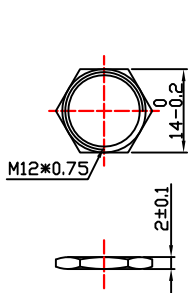

1			NAME	SF12N-0202-20R-M	
2					
3					
NO	DATE	DESCRIPTION	DRAWING NO	SF12N-M	
TOLERANCE		SCALE	DRAWN BY	CHECK BY	APPROVED BY
less than 10 ±0.3		1:1	BGSJU		
above 10-30 ±0.5		DIMENSION			
above 30-100 ±1.0		mm	2015.06.03		