

PUSH  
1-2 ON

PUSH  
2-3 ON

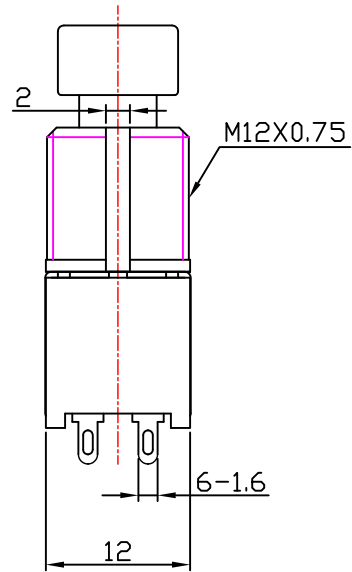
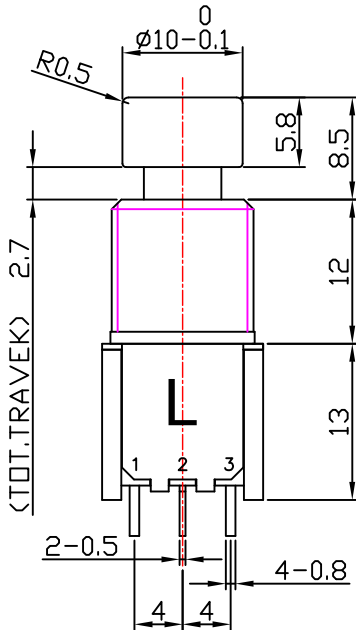

Fittings:

- Cu NUT \_\_\_PCS     Zn NUT \_\_\_PCS     WASHER \_\_\_PCS     20TEETH WASHER \_\_\_PCS     PA66 WASHER \_\_\_PCS     SPRING WASHER \_\_\_PCS

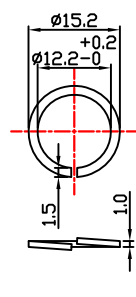
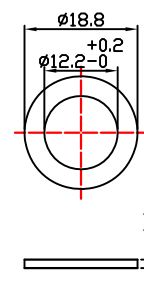
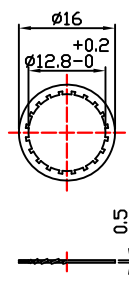
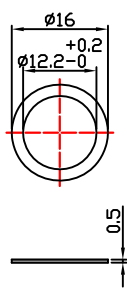
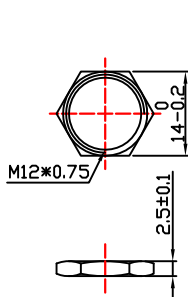
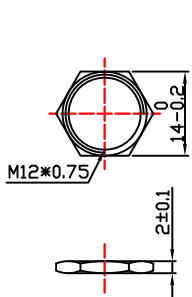

1			NAME	SF12N-0202-20R-L	
2					
3					
NO	DATE	DESCRIPTION	DRAWING NO	SF12N-L	
TOLERANCE		SCALE	DRAWN BY	CHECK BY	APPROVED BY
less than 10 ±0.3		1:1	BGSJU		
above 10-30 ±0.5		DIMENSION			
above 30-100 ±1.0		mm	2015.06.03		