

12V / 5W dual power amplifier

BA5406

The BA5406 is a dual-OTL monolithic power IC with two high-output, low-frequency power amplifiers. With a 12V power supply, it has a rated output of $5W \times 2$ into a 3Ω load, and with a 9V power supply, it has a rated output of $2.8W \times 2$ into a 3Ω load.

The BA5406 has good low-voltage characteristics, and the “pop” sound when power is applied is small. It generates little radio-band noise, and is ideal for use in stereo radio cassette players.

● Applications

Stereo radio cassette players, stereo component systems, and TVs.

● Features

- 1) Small “pop” noise.
- 2) Good low voltage characteristics. Begins operating $V_{CC} = 5V$ (Typ.).
- 3) Good channel balance.
- 4) Good distortion characteristics (THD = 0.3% when $P_O = 0.5W$).
- 5) Easy-to-mount 12-pin SIP-M package that requires little PCB space.
- 6) The ripple filter pin (pin 6) can be used for muting (by setting it to ground potential).
- 7) Symmetrical pin assignments simplifies PCB artwork.
- 8) Package has low thermal resistance to simplify heatsink design.
- 9) Built-in treble phase compensation capacitors.
- 10) Low radio-band noise generated. Can be freely positioned in the set.

● Block diagram

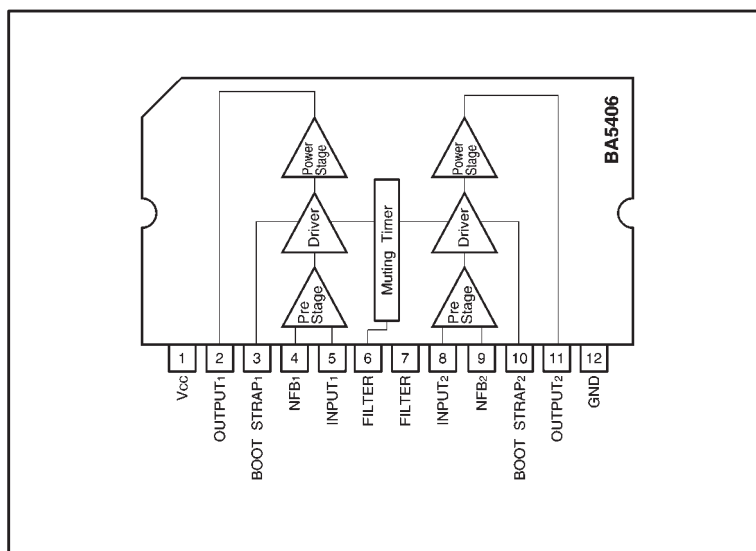

● Internal circuit configuration

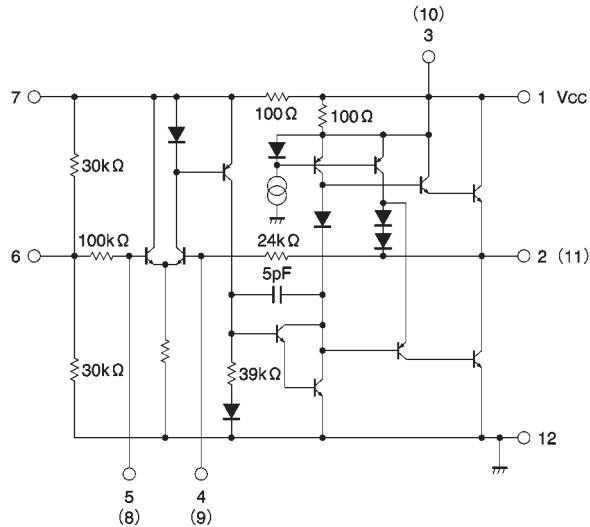

● Absolute maximum ratings (Ta = 25°C)

Parameter	Symbol	Limits	Unit
Power supply voltage	V _{CC}	18*1	V
Power dissipation	P _d	20*2	W
Operating temperature	T _{opr}	-20~+75	°C
Storage temperature	T _{stg}	-30~+125	°C
Junction temperature	T _j	150	°C

*1 No signal

*2 Back metal temperature: 75°C.

● Recommended operating conditions (Ta = 25°C)

Parameter	Symbol	Min.	Typ.	Max.	Unit
Power supply voltage	V _{CC}	5	12	15	V

● Electrical characteristics (unless otherwise noted, Ta = 25°C and V_{CC} = 12V)

Parameter	Symbol	Min.	Typ.	Max.	Unit	Conditions
Quiescent current	I _o	20	40	70	mA	V _{IN} =0V _{rms}
Closed loop voltage gain	G _{VC}	43	46	49	dB	f=1kHz, V _{IN} =-46dBm
Rated output 1	P _{OUT 1}	4.0	5.0	—	W	f=1kHz, THD=10%, R _L =3Ω
Rated output 2	P _{OUT 2}	3.4	4.2	—	W	f=1kHz, THD=10%, R _L =4Ω
Total harmonic distortion	THD	—	0.3	1.5	%	f=1kHz, P _O =0.5W
Output noise voltage	V _{NO}	—	0.6	1.0	mV _{rms}	R _g =10kΩ
Input resistance	R _{IN}	50	100	—	kΩ	f=1kHz, V _{IN} =5mV _{rms}

●Electrical characteristics curves

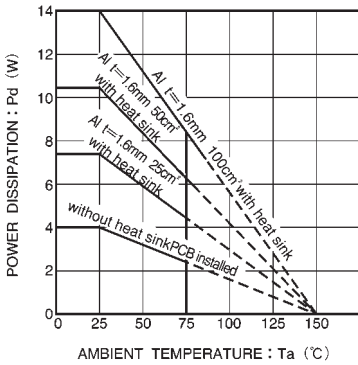

Fig. 3 Thermal derating curve

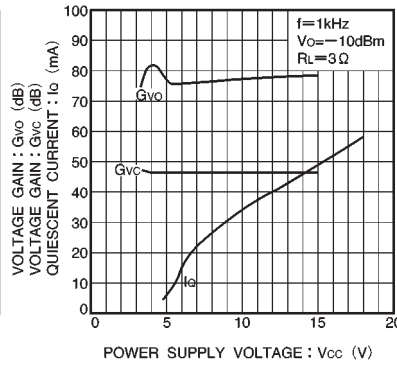

Fig. 4 Quiescent current and voltage gain vs. power supply voltage

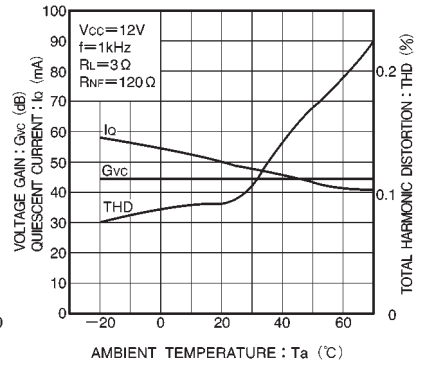

Fig. 5 Distortion, voltage gain and quiescent current vs. frequency

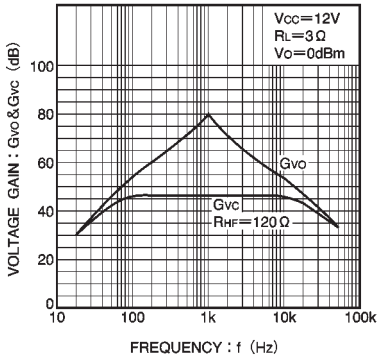

Fig. 6 Voltage gain vs. frequency

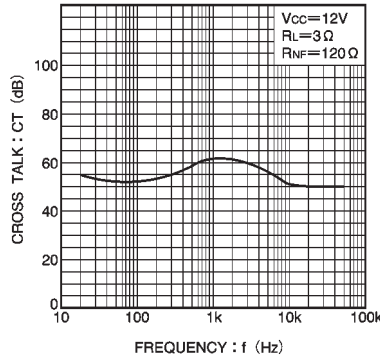

Fig. 7 Crosstalk vs. frequency

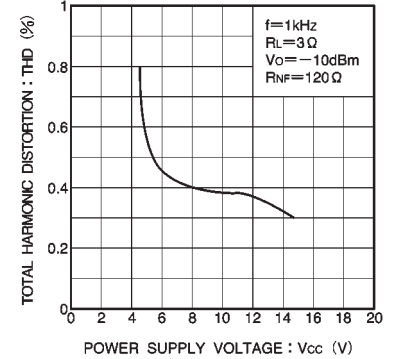

Fig. 8 Distortion vs. power supply voltage

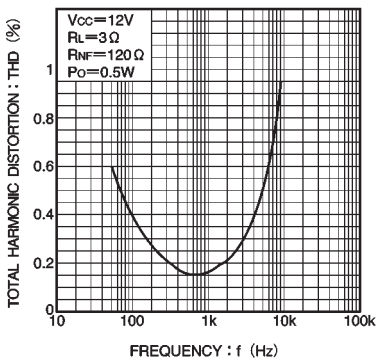

Fig. 9 Distortion vs. frequency

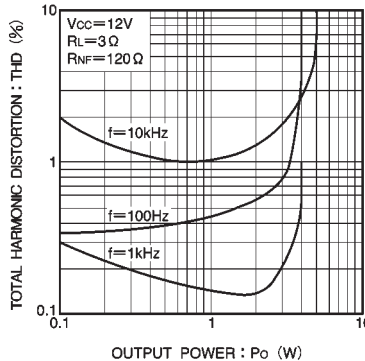

Fig. 10 Distortion vs. Output power

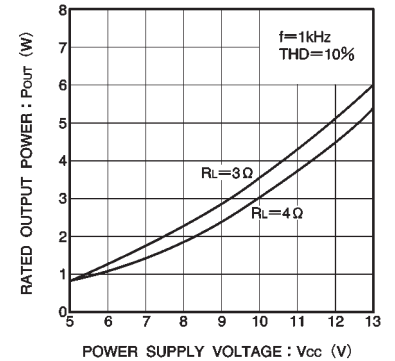

Fig. 11 Output power vs. power supply voltage

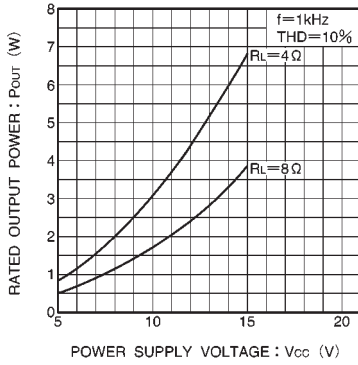

Fig. 12 Output power vs. power supply voltage

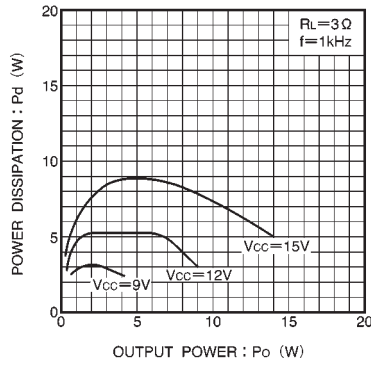

Fig. 13 Power dissipation vs. output power (I)

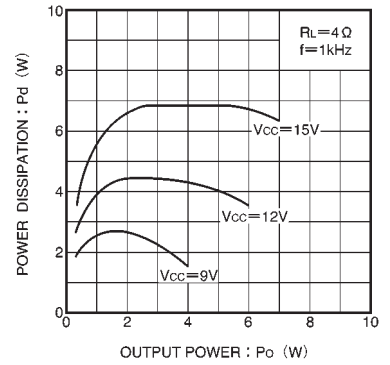

Fig. 14 Power dissipation vs. output power (II)

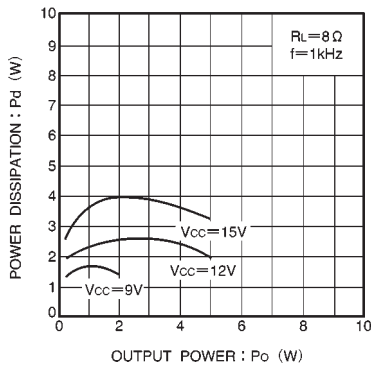

Fig. 15 Power dissipation vs. output power (III)

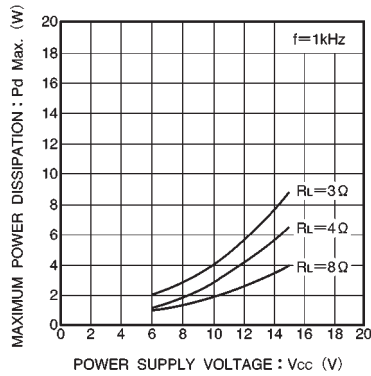

Fig. 16 Maximum power dissipation vs. power supply voltage

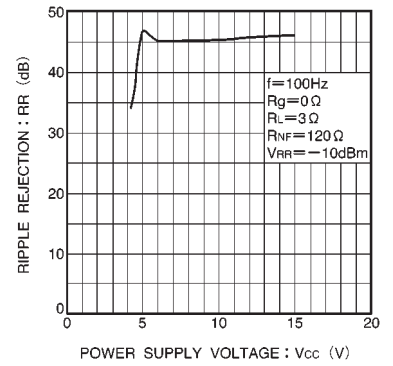
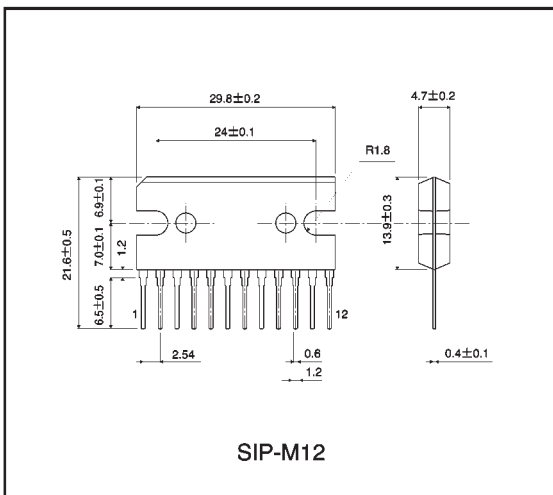

Fig. 17 Ripple rejection ratio vs. power supply voltage

● External dimensions (Units: mm)



This datasheet has been download from:

www.datasheetcatalog.com

Datasheets for electronics components.