

## Features

- High Performance, Low Power AVR<sup>®</sup> 8-Bit Microcontroller
- Advanced RISC Architecture
  - 120 Powerful Instructions – Most Single Clock Cycle Execution
  - 32 x 8 General Purpose Working Registers
  - Fully Static Operation
- Non-volatile Program and Data Memories
  - 2/4/8K Bytes of In-System Programmable Program Memory Flash
    - Endurance: 10,000 Write/Erase Cycles
  - 128/256/512 Bytes In-System Programmable EEPROM
    - Endurance: 100,000 Write/Erase Cycles
  - 128/256/512 Bytes Internal SRAM
  - Programming Lock for Self-Programming Flash Program and EEPROM Data Security
- Peripheral Features
  - 8-bit Timer/Counter with Prescaler and Two PWM Channels
  - 8-bit High Speed Timer/Counter with Separate Prescaler
    - 2 High Frequency PWM Outputs with Separate Output Compare Registers
    - Programmable Dead Time Generator
  - USI – Universal Serial Interface with Start Condition Detector
  - 10-bit ADC
    - 4 Single Ended Channels
    - 2 Differential ADC Channel Pairs with Programmable Gain (1x, 20x)
    - Temperature Measurement
  - Programmable Watchdog Timer with Separate On-chip Oscillator
  - On-chip Analog Comparator
- Special Microcontroller Features
  - debugWIRE On-chip Debug System
  - In-System Programmable via SPI Port
  - External and Internal Interrupt Sources
  - Low Power Idle, ADC Noise Reduction, and Power-down Modes
  - Enhanced Power-on Reset Circuit
  - Programmable Brown-out Detection Circuit
  - Internal Calibrated Oscillator
- I/O and Packages
  - Six Programmable I/O Lines
  - 8-pin PDIP, 8-pin SOIC, 20-pad QFN/MLF, and 8-pin TSSOP (only ATtiny45/V)
- Operating Voltage
  - 1.8 - 5.5V for ATtiny25V/45V/85V
  - 2.7 - 5.5V for ATtiny25/45/85
- Speed Grade
  - ATtiny25V/45V/85V: 0 – 4 MHz @ 1.8 - 5.5V, 0 - 10 MHz @ 2.7 - 5.5V
  - ATtiny25/45/85: 0 – 10 MHz @ 2.7 - 5.5V, 0 - 20 MHz @ 4.5 - 5.5V
- Industrial Temperature Range
- Low Power Consumption
  - Active Mode:
    - 1 MHz, 1.8V: 300  $\mu$ A
  - Power-down Mode:
    - 0.1  $\mu$ A at 1.8V



## 8-bit AVR<sup>®</sup> Microcontroller with 2/4/8K Bytes In-System Programmable Flash

ATtiny25/V  
ATtiny45/V  
ATtiny85/V

## Summary

Rev. 2586NS-AVR-04/11



# 1. Pin Configurations

Figure 1-1. Pinout ATtiny25/45/85

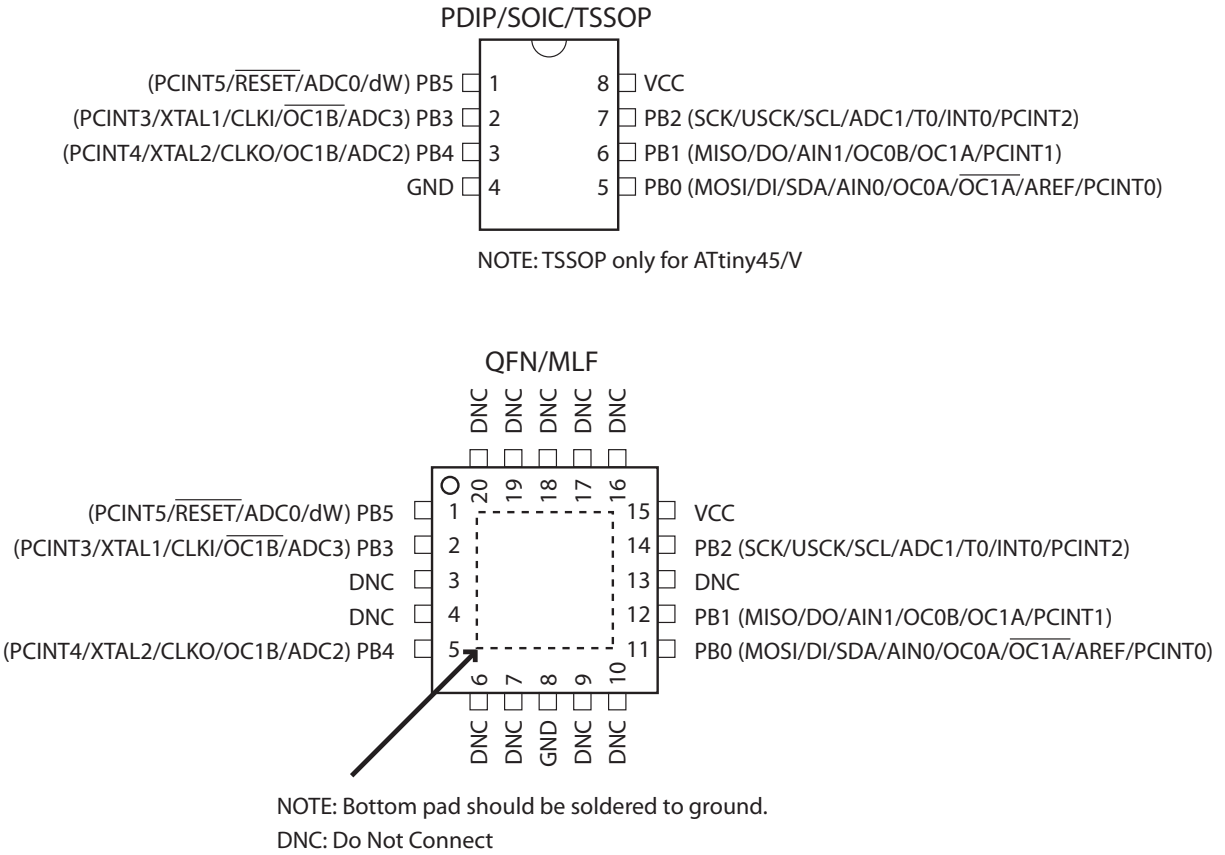

## 1.1 Pin Descriptions

### 1.1.1 VCC

Supply voltage.

### 1.1.2 GND

Ground.

### 1.1.3 Port B (PB5:PB0)

Port B is a 6-bit bi-directional I/O port with internal pull-up resistors (selected for each bit). The Port B output buffers have symmetrical drive characteristics with both high sink and source capability. As inputs, Port B pins that are externally pulled low will source current if the pull-up

resistors are activated. The Port B pins are tri-stated when a reset condition becomes active, even if the clock is not running.

Port B also serves the functions of various special features of the ATtiny25/45/85 as listed in [“Alternate Functions of Port B” on page 62](#).

On ATtiny25, the programmable I/O ports PB3 and PB4 (pins 2 and 3) are exchanged in ATtiny15 Compatibility Mode for supporting the backward compatibility with ATtiny15.

## 1.1.4 **RESET**

Reset input. A low level on this pin for longer than the minimum pulse length will generate a reset, even if the clock is not running and provided the reset pin has not been disabled. The minimum pulse length is given in [Table 21-4 on page 170](#). Shorter pulses are not guaranteed to generate a reset.

The reset pin can also be used as a (weak) I/O pin.

## 2. Overview

The ATtiny25/45/85 is a low-power CMOS 8-bit microcontroller based on the AVR enhanced RISC architecture. By executing powerful instructions in a single clock cycle, the ATtiny25/45/85 achieves throughputs approaching 1 MIPS per MHz allowing the system designer to optimize power consumption versus processing speed.

### 2.1 Block Diagram

Figure 2-1. Block Diagram

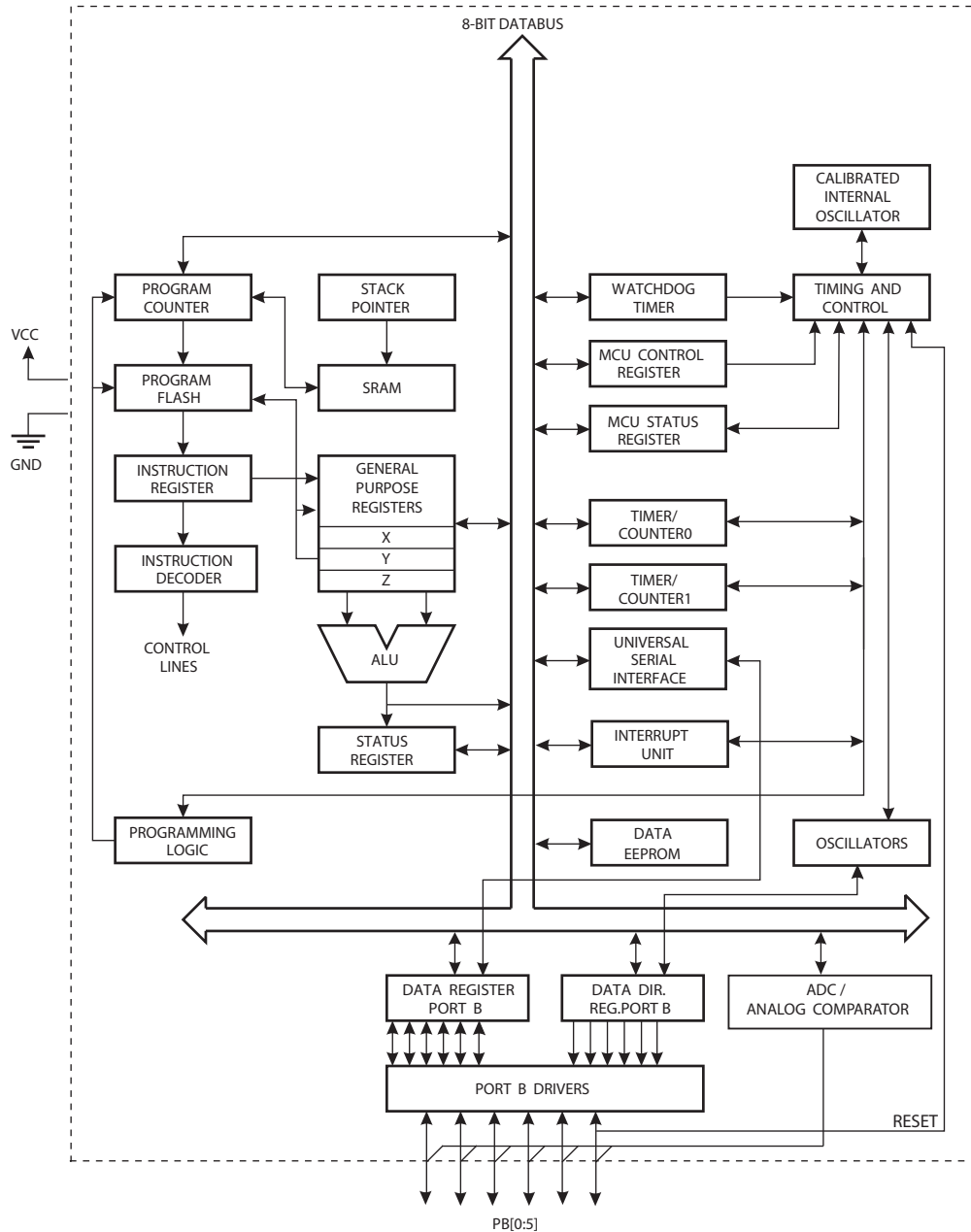

The AVR core combines a rich instruction set with 32 general purpose working registers. All 32 registers are directly connected to the Arithmetic Logic Unit (ALU), allowing two independent

registers to be accessed in one single instruction executed in one clock cycle. The resulting architecture is more code efficient while achieving throughputs up to ten times faster than conventional CISC microcontrollers.

The ATtiny25/45/85 provides the following features: 2/4/8K bytes of In-System Programmable Flash, 128/256/512 bytes EEPROM, 128/256/256 bytes SRAM, 6 general purpose I/O lines, 32 general purpose working registers, one 8-bit Timer/Counter with compare modes, one 8-bit high speed Timer/Counter, Universal Serial Interface, Internal and External Interrupts, a 4-channel, 10-bit ADC, a programmable Watchdog Timer with internal Oscillator, and three software selectable power saving modes. Idle mode stops the CPU while allowing the SRAM, Timer/Counter, ADC, Analog Comparator, and Interrupt system to continue functioning. Power-down mode saves the register contents, disabling all chip functions until the next Interrupt or Hardware Reset. ADC Noise Reduction mode stops the CPU and all I/O modules except ADC, to minimize switching noise during ADC conversions.

The device is manufactured using Atmel's high density non-volatile memory technology. The On-chip ISP Flash allows the Program memory to be re-programmed In-System through an SPI serial interface, by a conventional non-volatile memory programmer or by an On-chip boot code running on the AVR core.

The ATtiny25/45/85 AVR is supported with a full suite of program and system development tools including: C Compilers, Macro Assemblers, Program Debugger/Simulators and Evaluation kits.

## 3. About

### 3.1 Resources

A comprehensive set of development tools, application notes and datasheets are available for download on <http://www.atmel.com/avr>.

### 3.2 Code Examples

This documentation contains simple code examples that briefly show how to use various parts of the device. These code examples assume that the part specific header file is included before compilation. Be aware that not all C compiler vendors include bit definitions in the header files and interrupt handling in C is compiler dependent. Please confirm with the C compiler documentation for more details.

For I/O Registers located in the extended I/O map, “IN”, “OUT”, “SBIS”, “SBIC”, “CBI”, and “SBI” instructions must be replaced with instructions that allow access to extended I/O. Typically, this means “LDS” and “STS” combined with “SBRS”, “SBRC”, “SBR”, and “CBR”. Note that not all AVR devices include an extended I/O map.

### 3.3 Capacitive Touch Sensing

Atmel QTouch Library provides a simple to use solution for touch sensitive interfaces on Atmel AVR microcontrollers. The QTouch Library includes support for QTouch<sup>®</sup> and QMatrix<sup>®</sup> acquisition methods.

Touch sensing is easily added to any application by linking the QTouch Library and using the Application Programming Interface (API) of the library to define the touch channels and sensors. The application then calls the API to retrieve channel information and determine the state of the touch sensor.

The QTouch Library is free and can be downloaded from the Atmel website. For more information and details of implementation, refer to the QTouch Library User Guide – also available from the Atmel website.

### 3.4 Data Retention

Reliability Qualification results show that the projected data retention failure rate is much less than 1 PPM over 20 years at 85°C or 100 years at 25°C.

## 4. Register Summary

Address	Name	Bit 7	Bit 6	Bit 5	Bit 4	Bit 3	Bit 2	Bit 1	Bit 0	Page	
0x3F	SREG	I	T	H	S	V	N	Z	C	<a href="#">page 8</a>	
0x3E	SPH	–	–	–	–	–	–	SP9	SP8	<a href="#">page 11</a>	
0x3D	SPL	SP7	SP6	SP5	SP4	SP3	SP2	SP1	SP0	<a href="#">page 11</a>	
0x3C	Reserved	–									
0x3B	GIMSK	–	INT0	PCIE	–	–	–	–	–	<a href="#">page 53</a>	
0x3A	GIFR	–	INTF0	PCIF	–	–	–	–	–	<a href="#">page 54</a>	
0x39	TIMSK	–	OCIE1A	OCIE1B	OCIE0A	OCIE0B	TOIE1	TOIE0	–	<a href="#">pages 84, 106</a>	
0x38	TIFR	–	OCF1A	OCF1B	OCF0A	OCF0B	TOV1	TOV0	–	<a href="#">page 84</a>	
0x37	SPMCSR	–	–	RSIG	CTPB	RFLB	PGWRT	PGERS	SPMEN	<a href="#">page 149</a>	
0x36	Reserved	–									
0x35	MCUCR	BODS	PUD	SE	SM1	SM0	BODSE	ISC01	ISC00	<a href="#">pages 38, 53, 66</a>	
0x34	MCUSR	–	–	–	–	WDRF	BORF	EXTRF	PORF	<a href="#">page 46,</a>	
0x33	TCCR0B	FOC0A	FOC0B	–	–	WGM02	CS02	CS01	CS00	<a href="#">page 82</a>	
0x32	TCNT0	Timer/Counter0									<a href="#">page 83</a>
0x31	OSCCAL	Oscillator Calibration Register									<a href="#">page 32</a>
0x30	TCCR1	CTC1	PWM1A	COM1A1	COM1A0	CS13	CS12	CS11	CS10	<a href="#">pages 92, 103</a>	
0x2F	TCNT1	Timer/Counter1									<a href="#">pages 94, 105</a>
0x2E	OCR1A	Timer/Counter1 Output Compare Register A									<a href="#">pages 94, 105</a>
0x2D	OCR1C	Timer/Counter1 Output Compare Register C									<a href="#">pages 95, 106</a>
0x2C	GTCCR	TSM	PWM1B	COM1B1	COM1B0	FOC1B	FOC1A	PSR1	PSR0	<a href="#">pages 80, 93, 105</a>	
0x2B	OCR1B	Timer/Counter1 Output Compare Register B									<a href="#">page 95</a>
0x2A	TCCR0A	COM0A1	COM0A0	COM0B1	COM0B0	–	–	WGM01	WGM00	<a href="#">page 80</a>	
0x29	OCR0A	Timer/Counter0 – Output Compare Register A									<a href="#">page 83</a>
0x28	OCR0B	Timer/Counter0 – Output Compare Register B									<a href="#">page 84</a>
0x27	PLLCSR	LSM	–	–	–	–	PCKE	PLLE	PLOCK	<a href="#">pages 97, 107</a>	
0x26	CLKPR	CLKPCE	–	–	–	CLKPS3	CLKPS2	CLKPS1	CLKPS0	<a href="#">page 33</a>	
0x25	DT1A	DT1AH3	DT1AH2	DT1AH1	DT1AH0	DT1AL3	DT1AL2	DT1AL1	DT1AL0	<a href="#">page 110</a>	
0x24	DT1B	DT1BH3	DT1BH2	DT1BH1	DT1BH0	DT1BL3	DT1BL2	DT1BL1	DT1BL0	<a href="#">page 110</a>	
0x23	DTPS1	–	–	–	–	–	–	DTPS11	DTPS10	<a href="#">page 109</a>	
0x22	DWDR	DWDR[7:0]									<a href="#">page 144</a>
0x21	WDTCR	WDIF	WDIE	WDP3	WDCE	WDE	WDP2	WDP1	WDP0	<a href="#">page 47</a>	
0x20	PRR	–	–	–	–	PRTIM1	PRTIM0	PRUSI	PRADC	<a href="#">page 37</a>	
0x1F	EEARH	–	–	–	–	–	–	–	EEAR8	<a href="#">page 20</a>	
0x1E	EEARL	EEAR7	EEAR6	EEAR5	EEAR4	EEAR3	EEAR2	EEAR1	EEAR0	<a href="#">page 20</a>	
0x1D	EEDR	EEPROM Data Register									<a href="#">page 20</a>
0x1C	EEDR	–	–	EEDR1	EEDR0	EERIE	EEMPE	EEPE	EERE	<a href="#">page 21</a>	
0x1B	Reserved	–									
0x1A	Reserved	–									
0x19	Reserved	–									
0x18	PORTB	–	–	PORTB5	PORTB4	PORTB3	PORTB2	PORTB1	PORTB0	<a href="#">page 66</a>	
0x17	DDRB	–	–	DDB5	DDB4	DDB3	DDB2	DDB1	DDB0	<a href="#">page 66</a>	
0x16	PINB	–	–	PINB5	PINB4	PINB3	PINB2	PINB1	PINB0	<a href="#">page 66</a>	
0x15	PCMSK	–	–	PCINT5	PCINT4	PCINT3	PCINT2	PCINT1	PCINT0	<a href="#">page 54</a>	
0x14	DIDR0	–	–	ADC0D	ADC2D	ADC3D	ADC1D	AIN1D	AIN0D	<a href="#">pages 125, 142</a>	
0x13	GPIOR2	General Purpose I/O Register 2									<a href="#">page 10</a>
0x12	GPIOR1	General Purpose I/O Register 1									<a href="#">page 10</a>
0x11	GPIOR0	General Purpose I/O Register 0									<a href="#">page 10</a>
0x10	USIBR	USI Buffer Register									<a href="#">page 118</a>
0x0F	USIDR	USI Data Register									<a href="#">page 118</a>
0x0E	USISR	USISIF	USIOIF	USIPF	USIDC	USICNT3	USICNT2	USICNT1	USICNT0	<a href="#">page 119</a>	
0x0D	USICR	USISIE	USIOIE	USIWM1	USIWM0	USICS1	USICS0	USICK	USITC	<a href="#">page 120</a>	
0x0C	Reserved	–									
0x0B	Reserved	–									
0x0A	Reserved	–									
0x09	Reserved	–									
0x08	ACSR	ACD	ACBG	ACO	ACI	ACIE	–	ACIS1	ACIS0	<a href="#">page 124</a>	
0x07	ADMUX	REFS1	REFS0	ADLAR	REFS2	MUX3	MUX2	MUX1	MUX0	<a href="#">page 138</a>	
0x06	ADCSRA	ADEN	ADSC	ADATE	ADIF	ADIE	ADPS2	ADPS1	ADPS0	<a href="#">page 140</a>	
0x05	ADCH	ADC Data Register High Byte									<a href="#">page 141</a>
0x04	ADCL	ADC Data Register Low Byte									<a href="#">page 141</a>
0x03	ADCSRB	BIN	ACME	IPR	–	–	ADTS2	ADTS1	ADTS0	<a href="#">pages 124, 141</a>	
0x02	Reserved	–									
0x01	Reserved	–									
0x00	Reserved	–									



- Note:
1. For compatibility with future devices, reserved bits should be written to zero if accessed. Reserved I/O memory addresses should never be written.
  2. I/O Registers within the address range 0x00 - 0x1F are directly bit-accessible using the SBI and CBI instructions. In these registers, the value of single bits can be checked by using the SBIS and SBIC instructions.
  3. Some of the Status Flags are cleared by writing a logical one to them. Note that, unlike most other AVR's, the CBI and SBI instructions will only operation the specified bit, and can therefore be used on registers containing such Status Flags. The CBI and SBI instructions work with registers 0x00 to 0x1F only.



## 5. Instruction Set Summary

Mnemonics	Operands	Description	Operation	Flags	#Clocks
<b>ARITHMETIC AND LOGIC INSTRUCTIONS</b>					
ADD	Rd, Rr	Add two Registers	$Rd \leftarrow Rd + Rr$	Z,C,N,V,H	1
ADC	Rd, Rr	Add with Carry two Registers	$Rd \leftarrow Rd + Rr + C$	Z,C,N,V,H	1
ADIW	Rd,K	Add Immediate to Word	$Rdh:Rdl \leftarrow Rdh:Rdl + K$	Z,C,N,V,S	2
SUB	Rd, Rr	Subtract two Registers	$Rd \leftarrow Rd - Rr$	Z,C,N,V,H	1
SUBI	Rd, K	Subtract Constant from Register	$Rd \leftarrow Rd - K$	Z,C,N,V,H	1
SBC	Rd, Rr	Subtract with Carry two Registers	$Rd \leftarrow Rd - Rr - C$	Z,C,N,V,H	1
SBCI	Rd, K	Subtract with Carry Constant from Reg.	$Rd \leftarrow Rd - K - C$	Z,C,N,V,H	1
SBIW	Rd,K	Subtract Immediate from Word	$Rdh:Rdl \leftarrow Rdh:Rdl - K$	Z,C,N,V,S	2
AND	Rd, Rr	Logical AND Registers	$Rd \leftarrow Rd \bullet Rr$	Z,N,V	1
ANDI	Rd, K	Logical AND Register and Constant	$Rd \leftarrow Rd \bullet K$	Z,N,V	1
OR	Rd, Rr	Logical OR Registers	$Rd \leftarrow Rd \vee Rr$	Z,N,V	1
ORI	Rd, K	Logical OR Register and Constant	$Rd \leftarrow Rd \vee K$	Z,N,V	1
EOR	Rd, Rr	Exclusive OR Registers	$Rd \leftarrow Rd \oplus Rr$	Z,N,V	1
COM	Rd	One's Complement	$Rd \leftarrow 0xFF - Rd$	Z,C,N,V	1
NEG	Rd	Two's Complement	$Rd \leftarrow 0x00 - Rd$	Z,C,N,V,H	1
SBR	Rd,K	Set Bit(s) in Register	$Rd \leftarrow Rd \vee K$	Z,N,V	1
CBR	Rd,K	Clear Bit(s) in Register	$Rd \leftarrow Rd \bullet (0xFF - K)$	Z,N,V	1
INC	Rd	Increment	$Rd \leftarrow Rd + 1$	Z,N,V	1
DEC	Rd	Decrement	$Rd \leftarrow Rd - 1$	Z,N,V	1
TST	Rd	Test for Zero or Minus	$Rd \leftarrow Rd \bullet Rd$	Z,N,V	1
CLR	Rd	Clear Register	$Rd \leftarrow Rd \oplus Rd$	Z,N,V	1
SER	Rd	Set Register	$Rd \leftarrow 0xFF$	None	1
<b>BRANCH INSTRUCTIONS</b>					
RJMP	k	Relative Jump	$PC \leftarrow PC + k + 1$	None	2
IJMP		Indirect Jump to (Z)	$PC \leftarrow Z$	None	2
RCALL	k	Relative Subroutine Call	$PC \leftarrow PC + k + 1$	None	3
ICALL		Indirect Call to (Z)	$PC \leftarrow Z$	None	3
RET		Subroutine Return	$PC \leftarrow STACK$	None	4
RETI		Interrupt Return	$PC \leftarrow STACK$	I	4
CPSE	Rd,Rr	Compare, Skip if Equal	if (Rd = Rr) $PC \leftarrow PC + 2$ or 3	None	1/2/3
CP	Rd,Rr	Compare	$Rd - Rr$	Z, N, V, C, H	1
CPC	Rd,Rr	Compare with Carry	$Rd - Rr - C$	Z, N, V, C, H	1
CPI	Rd,K	Compare Register with Immediate	$Rd - K$	Z, N, V, C, H	1
SBRC	Rr, b	Skip if Bit in Register Cleared	if (Rr(b)=0) $PC \leftarrow PC + 2$ or 3	None	1/2/3
SBRS	Rr, b	Skip if Bit in Register is Set	if (Rr(b)=1) $PC \leftarrow PC + 2$ or 3	None	1/2/3
SBIC	P, b	Skip if Bit in I/O Register Cleared	if (P(b)=0) $PC \leftarrow PC + 2$ or 3	None	1/2/3
SBIS	P, b	Skip if Bit in I/O Register is Set	if (P(b)=1) $PC \leftarrow PC + 2$ or 3	None	1/2/3
BRBS	s, k	Branch if Status Flag Set	if (SREG(s) = 1) then $PC \leftarrow PC + k + 1$	None	1/2
BRBC	s, k	Branch if Status Flag Cleared	if (SREG(s) = 0) then $PC \leftarrow PC + k + 1$	None	1/2
BREQ	k	Branch if Equal	if (Z = 1) then $PC \leftarrow PC + k + 1$	None	1/2
BRNE	k	Branch if Not Equal	if (Z = 0) then $PC \leftarrow PC + k + 1$	None	1/2
BRCS	k	Branch if Carry Set	if (C = 1) then $PC \leftarrow PC + k + 1$	None	1/2
BRCC	k	Branch if Carry Cleared	if (C = 0) then $PC \leftarrow PC + k + 1$	None	1/2
BRSH	k	Branch if Same or Higher	if (C = 0) then $PC \leftarrow PC + k + 1$	None	1/2
BRLO	k	Branch if Lower	if (C = 1) then $PC \leftarrow PC + k + 1$	None	1/2
BRMI	k	Branch if Minus	if (N = 1) then $PC \leftarrow PC + k + 1$	None	1/2
BRPL	k	Branch if Plus	if (N = 0) then $PC \leftarrow PC + k + 1$	None	1/2
BRGE	k	Branch if Greater or Equal, Signed	if (N $\oplus$ V = 0) then $PC \leftarrow PC + k + 1$	None	1/2
BRLT	k	Branch if Less Than Zero, Signed	if (N $\oplus$ V = 1) then $PC \leftarrow PC + k + 1$	None	1/2
BRHS	k	Branch if Half Carry Flag Set	if (H = 1) then $PC \leftarrow PC + k + 1$	None	1/2
BRHC	k	Branch if Half Carry Flag Cleared	if (H = 0) then $PC \leftarrow PC + k + 1$	None	1/2
BRTS	k	Branch if T Flag Set	if (T = 1) then $PC \leftarrow PC + k + 1$	None	1/2
BRTC	k	Branch if T Flag Cleared	if (T = 0) then $PC \leftarrow PC + k + 1$	None	1/2
BRVS	k	Branch if Overflow Flag is Set	if (V = 1) then $PC \leftarrow PC + k + 1$	None	1/2
BRVC	k	Branch if Overflow Flag is Cleared	if (V = 0) then $PC \leftarrow PC + k + 1$	None	1/2
BRIE	k	Branch if Interrupt Enabled	if (I = 1) then $PC \leftarrow PC + k + 1$	None	1/2
BRID	k	Branch if Interrupt Disabled	if (I = 0) then $PC \leftarrow PC + k + 1$	None	1/2
<b>BIT AND BIT-TEST INSTRUCTIONS</b>					
SBI	P,b	Set Bit in I/O Register	$I/O(P,b) \leftarrow 1$	None	2
CBI	P,b	Clear Bit in I/O Register	$I/O(P,b) \leftarrow 0$	None	2
LSL	Rd	Logical Shift Left	$Rd(n+1) \leftarrow Rd(n), Rd(0) \leftarrow 0$	Z,C,N,V	1
LSR	Rd	Logical Shift Right	$Rd(n) \leftarrow Rd(n+1), Rd(7) \leftarrow 0$	Z,C,N,V	1
ROL	Rd	Rotate Left Through Carry	$Rd(0) \leftarrow C, Rd(n+1) \leftarrow Rd(n), C \leftarrow Rd(7)$	Z,C,N,V	1
ROR	Rd	Rotate Right Through Carry	$Rd(7) \leftarrow C, Rd(n) \leftarrow Rd(n+1), C \leftarrow Rd(0)$	Z,C,N,V	1



Mnemonics	Operands	Description	Operation	Flags	#Clocks
ASR	Rd	Arithmetic Shift Right	$Rd(n) \leftarrow Rd(n+1), n=0..6$	Z,C,N,V	1
SWAP	Rd	Swap Nibbles	$Rd(3..0) \leftarrow Rd(7..4), Rd(7..4) \leftarrow Rd(3..0)$	None	1
BSET	s	Flag Set	$SREG(s) \leftarrow 1$	SREG(s)	1
BCLR	s	Flag Clear	$SREG(s) \leftarrow 0$	SREG(s)	1
BST	Rr, b	Bit Store from Register to T	$T \leftarrow Rr(b)$	T	1
BLD	Rd, b	Bit load from T to Register	$Rd(b) \leftarrow T$	None	1
SEC		Set Carry	$C \leftarrow 1$	C	1
CLC		Clear Carry	$C \leftarrow 0$	C	1
SEN		Set Negative Flag	$N \leftarrow 1$	N	1
CLN		Clear Negative Flag	$N \leftarrow 0$	N	1
SEZ		Set Zero Flag	$Z \leftarrow 1$	Z	1
CLZ		Clear Zero Flag	$Z \leftarrow 0$	Z	1
SEI		Global Interrupt Enable	$I \leftarrow 1$	I	1
CLI		Global Interrupt Disable	$I \leftarrow 0$	I	1
SES		Set Signed Test Flag	$S \leftarrow 1$	S	1
CLS		Clear Signed Test Flag	$S \leftarrow 0$	S	1
SEV		Set Twos Complement Overflow.	$V \leftarrow 1$	V	1
CLV		Clear Twos Complement Overflow	$V \leftarrow 0$	V	1
SET		Set T in SREG	$T \leftarrow 1$	T	1
CLT		Clear T in SREG	$T \leftarrow 0$	T	1
SEH		Set Half Carry Flag in SREG	$H \leftarrow 1$	H	1
CLH		Clear Half Carry Flag in SREG	$H \leftarrow 0$	H	1
<b>DATA TRANSFER INSTRUCTIONS</b>					
MOV	Rd, Rr	Move Between Registers	$Rd \leftarrow Rr$	None	1
MOVW	Rd, Rr	Copy Register Word	$Rd+1:Rd \leftarrow Rr+1:Rr$	None	1
LDI	Rd, K	Load Immediate	$Rd \leftarrow K$	None	1
LD	Rd, X	Load Indirect	$Rd \leftarrow (X)$	None	2
LD	Rd, X+	Load Indirect and Post-Inc.	$Rd \leftarrow (X), X \leftarrow X + 1$	None	2
LD	Rd, -X	Load Indirect and Pre-Dec.	$X \leftarrow X - 1, Rd \leftarrow (X)$	None	2
LD	Rd, Y	Load Indirect	$Rd \leftarrow (Y)$	None	2
LD	Rd, Y+	Load Indirect and Post-Inc.	$Rd \leftarrow (Y), Y \leftarrow Y + 1$	None	2
LD	Rd, -Y	Load Indirect and Pre-Dec.	$Y \leftarrow Y - 1, Rd \leftarrow (Y)$	None	2
LDD	Rd, Y+q	Load Indirect with Displacement	$Rd \leftarrow (Y + q)$	None	2
LD	Rd, Z	Load Indirect	$Rd \leftarrow (Z)$	None	2
LD	Rd, Z+	Load Indirect and Post-Inc.	$Rd \leftarrow (Z), Z \leftarrow Z + 1$	None	2
LD	Rd, -Z	Load Indirect and Pre-Dec.	$Z \leftarrow Z - 1, Rd \leftarrow (Z)$	None	2
LDD	Rd, Z+q	Load Indirect with Displacement	$Rd \leftarrow (Z + q)$	None	2
LDS	Rd, k	Load Direct from SRAM	$Rd \leftarrow (k)$	None	2
ST	X, Rr	Store Indirect	$(X) \leftarrow Rr$	None	2
ST	X+, Rr	Store Indirect and Post-Inc.	$(X) \leftarrow Rr, X \leftarrow X + 1$	None	2
ST	-X, Rr	Store Indirect and Pre-Dec.	$X \leftarrow X - 1, (X) \leftarrow Rr$	None	2
ST	Y, Rr	Store Indirect	$(Y) \leftarrow Rr$	None	2
ST	Y+, Rr	Store Indirect and Post-Inc.	$(Y) \leftarrow Rr, Y \leftarrow Y + 1$	None	2
ST	-Y, Rr	Store Indirect and Pre-Dec.	$Y \leftarrow Y - 1, (Y) \leftarrow Rr$	None	2
STD	Y+q, Rr	Store Indirect with Displacement	$(Y + q) \leftarrow Rr$	None	2
ST	Z, Rr	Store Indirect	$(Z) \leftarrow Rr$	None	2
ST	Z+, Rr	Store Indirect and Post-Inc.	$(Z) \leftarrow Rr, Z \leftarrow Z + 1$	None	2
ST	-Z, Rr	Store Indirect and Pre-Dec.	$Z \leftarrow Z - 1, (Z) \leftarrow Rr$	None	2
STD	Z+q, Rr	Store Indirect with Displacement	$(Z + q) \leftarrow Rr$	None	2
STS	k, Rr	Store Direct to SRAM	$(k) \leftarrow Rr$	None	2
LPM		Load Program Memory	$R0 \leftarrow (Z)$	None	3
LPM	Rd, Z	Load Program Memory	$Rd \leftarrow (Z)$	None	3
LPM	Rd, Z+	Load Program Memory and Post-Inc	$Rd \leftarrow (Z), Z \leftarrow Z + 1$	None	3
SPM		Store Program Memory	$(z) \leftarrow R1:R0$	None	
IN	Rd, P	In Port	$Rd \leftarrow P$	None	1
OUT	P, Rr	Out Port	$P \leftarrow Rr$	None	1
PUSH	Rr	Push Register on Stack	$STACK \leftarrow Rr$	None	2
POP	Rd	Pop Register from Stack	$Rd \leftarrow STACK$	None	2
<b>MCU CONTROL INSTRUCTIONS</b>					
NOP		No Operation		None	1
SLEEP		Sleep	(see specific descr. for Sleep function)	None	1
WDR		Watchdog Reset	(see specific descr. for WDR/Timer)	None	1
BREAK		Break	For On-chip Debug Only	None	N/A

## 6. Ordering Information

### 6.1 ATtiny25

Speed (MHz) <sup>(1)</sup>	Supply Voltage (V)	Temperature Range	Package <sup>(2)</sup>	Ordering Code <sup>(3)</sup>
10	1.8 – 5.5	Industrial (-40°C to +85°C) <sup>(4)</sup>	8P3	ATtiny25V-10PU
			8S2	ATtiny25V-10SU ATtiny25V-10SUR ATtiny25V-10SH
			S8S1	ATtiny25V-10SSU ATtiny25V-10SSUR ATtiny25V-10SSH
			20M1	ATtiny25V-10MU ATtiny25V-10MUR
		Industrial (-40°C to +105°C) <sup>(5)</sup>	8S2	ATtiny25V-10SN ATtiny25V-10SNR
			S8S1	ATtiny25V-10SSN ATtiny25V-10SSNR
20	2.7 – 5.5	Industrial (-40°C to +85°C) <sup>(4)</sup>	8P3	ATtiny25-20PU
			8S2	ATtiny25-20SU ATtiny25-20SUR ATtiny25-20SH
			S8S1	ATtiny25-20SSU ATtiny25-20SSUR ATtiny25-20SSH
			20M1	ATtiny25-20MU ATtiny25-20MUR
		Industrial (-40°C to +105°C) <sup>(5)</sup>	8S2	ATtiny25-20SN ATtiny25-20SNR
			S8S1	ATtiny25-20SSN ATtiny25-20SSNR

- Notes:
- For speed vs. supply voltage, see section 21.3 "Speed" on page 168.
  - All packages are Pb-free, halide-free and fully green, and they comply with the European directive for Restriction of Hazardous Substances (RoHS).
  - Code indicators:
    - H: NiPdAu lead finish
    - U or N: matte tin
    - R: tape & reel
  - Can also be supplied in wafer form. Contact your local Atmel sales office for ordering information and minimum quantities.
  - For Typical and Electrical characteristics for this device please consult Appendix A, ATtiny25/V Specification at 105°C.

Package Types	
8P3	8-lead, 0.300" Wide, Plastic Dual Inline Package (PDIP)
8S2	8-lead, 0.208" Wide, Plastic Gull-Wing Small Outline (EIAJ SOIC)
S8S1	8-lead, 0.150" Wide, Plastic Gull-Wing Small Outline (JEDEC SOIC)
20M1	20-pad, 4 x 4 x 0.8 mm Body, Quad Flat No-Lead/Micro Lead Frame Package (QFN/MLF)

## 6.2 ATtiny45

Speed (MHz) <sup>(1)</sup>	Supply Voltage (V)	Temperature Range	Package <sup>(2)</sup>	Ordering Code <sup>(3)</sup>
10	1.8 – 5.5	Industrial (-40°C to +85°C) <sup>(4)</sup>	8P3	ATtiny45V-10PU
			8S2	ATtiny45V-10SU ATtiny45V-10SUR ATtiny45V-10SH
			8X	ATtiny45V-10XU ATtiny45V-10XUR
			20M1	ATtiny45V-10MU ATtiny45V-10MUR
20	2.7 – 5.5	Industrial (-40°C to +85°C) <sup>(4)</sup>	8P3	ATtiny45-20PU
			8S2	ATtiny45-20SU ATtiny45-20SUR ATtiny45-20SH
			8X	ATtiny45-20XU ATtiny45-20XUR
			20M1	ATtiny45-20MU ATtiny45-20MUR

- Notes:
- For speed vs. supply voltage, see section [21.3 “Speed” on page 168](#).
  - All packages are Pb-free, halide-free and fully green and they comply with the European directive for Restriction of Hazardous Substances (RoHS).
  - Code indicators:
    - H: NiPdAu lead finish
    - U: matte tin
    - R: tape & reel
  - These devices can also be supplied in wafer form. Please contact your local Atmel sales office for detailed ordering information and minimum quantities.

Package Types	
8P3	8-lead, 0.300" Wide, Plastic Dual Inline Package (PDIP)
8S2	8-lead, 0.208" Wide, Plastic Gull-Wing Small Outline (EIAJ SOIC)
8X	8-lead, 4.4 mm Wide, Plastic Thin Shrink Small Outline Package (TSSOP)
20M1	20-pad, 4 x 4 x 0.8 mm Body, Quad Flat No-Lead/Micro Lead Frame Package (QFN/MLF)

## 6.3 ATtiny85

Speed (MHz) <sup>(1)</sup>	Supply Voltage (V)	Temperature Range	Package <sup>(2)</sup>	Ordering Code <sup>(3)</sup>
10	1.8 – 5.5	Industrial (-40°C to +85°C) <sup>(4)</sup>	8P3	ATtiny85V-10PU
			8S2	ATtiny85V-10SU ATtiny85V-10SUR ATtiny85V-10SH
			20M1	ATtiny85V-10MU ATtiny85V-10MUR
20	2.7 – 5.5	Industrial (-40°C to +85°C) <sup>(4)</sup>	8P3	ATtiny85-20PU
			8S2	ATtiny85-20SU ATtiny85-20SUR ATtiny85-20SH
			20M1	ATtiny85-20MU ATtiny85-20MUR

- Notes:
- For speed vs. supply voltage, see section [21.3 "Speed" on page 168](#).
  - All packages are Pb-free, halide-free and fully green and they comply with the European directive for Restriction of Hazardous Substances (RoHS).
  - Code indicators:
    - H: NiPdAu lead finish
    - U: matte tin
    - R: tape & reel
  - These devices can also be supplied in wafer form. Please contact your local Atmel sales office for detailed ordering information and minimum quantities.

Package Types	
8P3	8-lead, 0.300" Wide, Plastic Dual Inline Package (PDIP)
8S2	8-lead, 0.208" Wide, Plastic Gull-Wing Small Outline (EIAJ SOIC)
20M1	20-pad, 4 x 4 x 0.8 mm Body, Quad Flat No-Lead/Micro Lead Frame Package (QFN/MLF)

## 7. Packaging Information

### 7.1 8P3

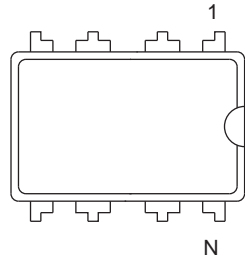

Top View

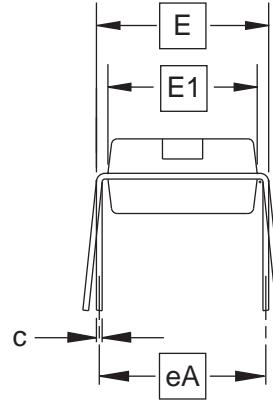

End View

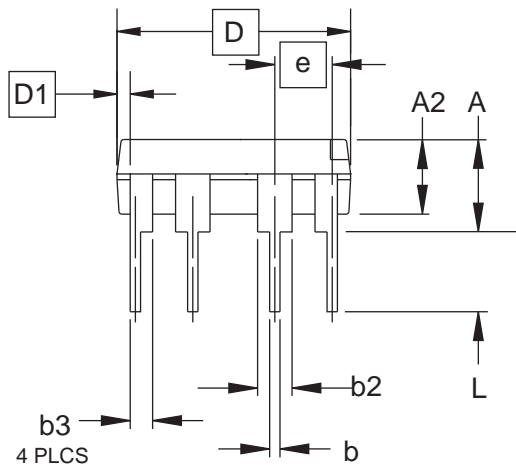

Side View

**COMMON DIMENSIONS**  
(Unit of Measure = inches)

SYMBOL	MIN	NOM	MAX	NOTE
A			0.210	2
A2	0.115	0.130	0.195	
b	0.014	0.018	0.022	5
b2	0.045	0.060	0.070	6
b3	0.030	0.039	0.045	6
c	0.008	0.010	0.014	
D	0.355	0.365	0.400	3
D1	0.005			3
E	0.300	0.310	0.325	4
E1	0.240	0.250	0.280	3
e	0.100 BSC			
eA	0.300 BSC			4
L	0.115	0.130	0.150	2

- Notes:
1. This drawing is for general information only; refer to JEDEC Drawing MS-001, Variation BA for additional information.
  2. Dimensions A and L are measured with the package seated in JEDEC seating plane Gauge GS-3.
  3. D, D1 and E1 dimensions do not include mold Flash or protrusions. Mold Flash or protrusions shall not exceed 0.010 inch.
  4. E and eA measured with the leads constrained to be perpendicular to datum.
  5. Pointed or rounded lead tips are preferred to ease insertion.
  6. b2 and b3 maximum dimensions do not include Dambar protrusions. Dambar protrusions shall not exceed 0.010 (0.25 mm).

01/09/02



2325 Orchard Parkway  
San Jose, CA 95131

**TITLE**  
**8P3, 8-lead, 0.300" Wide Body, Plastic Dual**  
In-line Package (PDIP)

**DRAWING NO.**  
8P3

**REV.**  
B

## 7.2 8S2

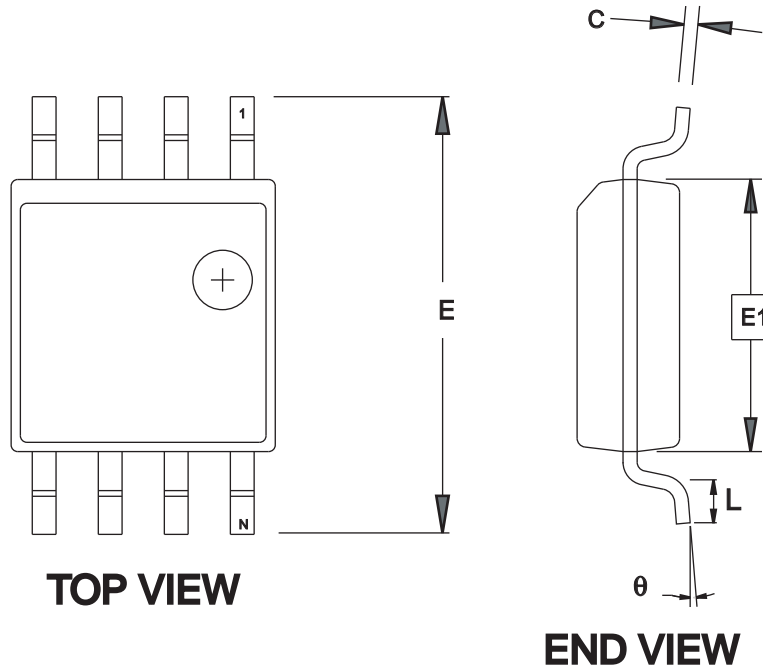

**COMMON DIMENSIONS**  
(Unit of Measure = mm)

SYMBOL	MIN	NOM	MAX	NOTE
A	1.70		2.16	
A1	0.05		0.25	
b	0.35		0.48	4
C	0.15		0.35	4
D	5.13		5.35	
E1	5.18		5.40	2
E	7.70		8.26	
L	0.51		0.85	
θ	0°		8°	
e	1.27 BSC			3

- Notes:
1. This drawing is for general information only; refer to EIAJ Drawing EDR-7320 for additional information.
  2. Mismatch of the upper and lower dies and resin burrs aren't included.
  3. Determines the true geometric position.
  4. Values b,C apply to plated terminal. The standard thickness of the plating layer shall measure between 0.007 to .021 mm.

4/15/08



**Package Drawing Contact:**  
packagedrawings@atmel.com

**TITLE**  
8S2, 8-lead, 0.208" Body, Plastic Small  
Outline Package (EIAJ)

**GPC**  
STN

**DRAWING NO.**  
8S2

**REV.**  
F



### 7.3 S8S1

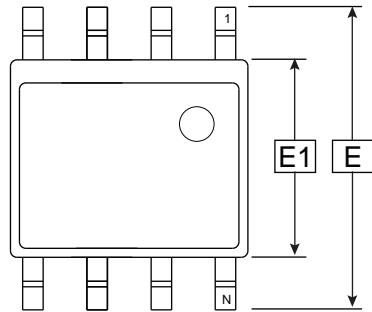

Top View

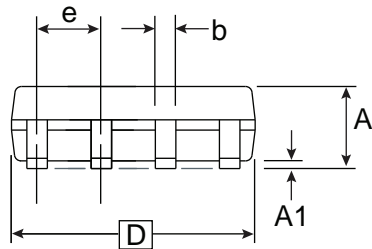

Side View

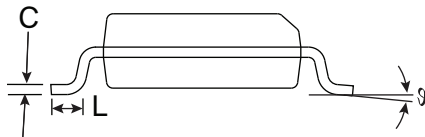

End View

**COMMON DIMENSIONS**  
(Unit of Measure = mm)

SYMBOL	MIN	NOM	MAX	NOTE
E	5.79		6.20	
E1	3.81		3.99	
A	1.35		1.75	
A1	0.1		0.25	
D	4.80		4.98	
C	0.17		0.25	
b	0.31		0.51	
L	0.4		1.27	
e	1.27 BSC			
∅	0°		8°	

Notes: 1. This drawing is for general information only; refer to JEDEC Drawing MS-012 for proper dimensions, tolerances, datums, etc.

7/28/03



2325 Orchard Parkway  
San Jose, CA 95131

**TITLE**

**S8S1**, 8-lead, 0.150" Wide Body, Plastic Gull Wing Small Outline (JEDEC SOIC)

**DRAWING NO.**

S8S1

**REV.**

A



## 7.4 8X

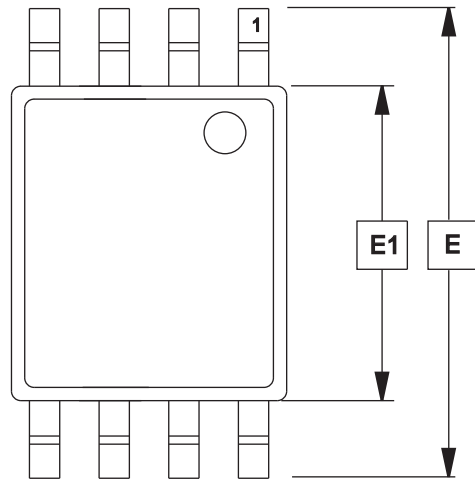

**Top View**



**End View**

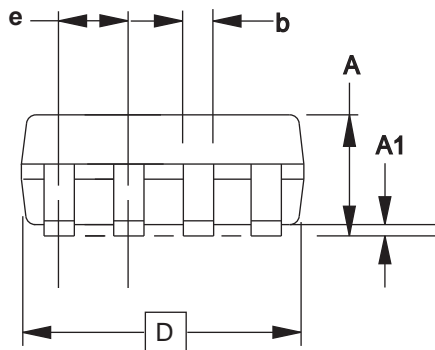

**Side View**

**COMMON DIMENSIONS**  
(Unit of Measure = mm)

SYMBOL	MIN	NOM	MAX	NOTE
A	1.05	1.10	1.20	
A1	0.05	0.10	0.15	
b	0.25	–	0.30	
C	–	0.127	–	
D	2.90	3.05	3.10	
E1	4.30	4.40	4.50	
E	6.20	6.40	6.60	
e	0.65 TYP			
L	0.50	0.60	0.70	
ø	0°	–	8°	

Note: These drawings are for general information only. Refer to JEDEC Drawing MO-153AC.

4/14/05



2325 Orchard Parkway  
San Jose, CA 95131

**TITLE**  
**8X**, 8-lead, 4.4 mm Body Width, Plastic Thin Shrink  
Small Outline Package (TSSOP)

**DRAWING NO.**

8X

**REV.**

A



7.5 20M1

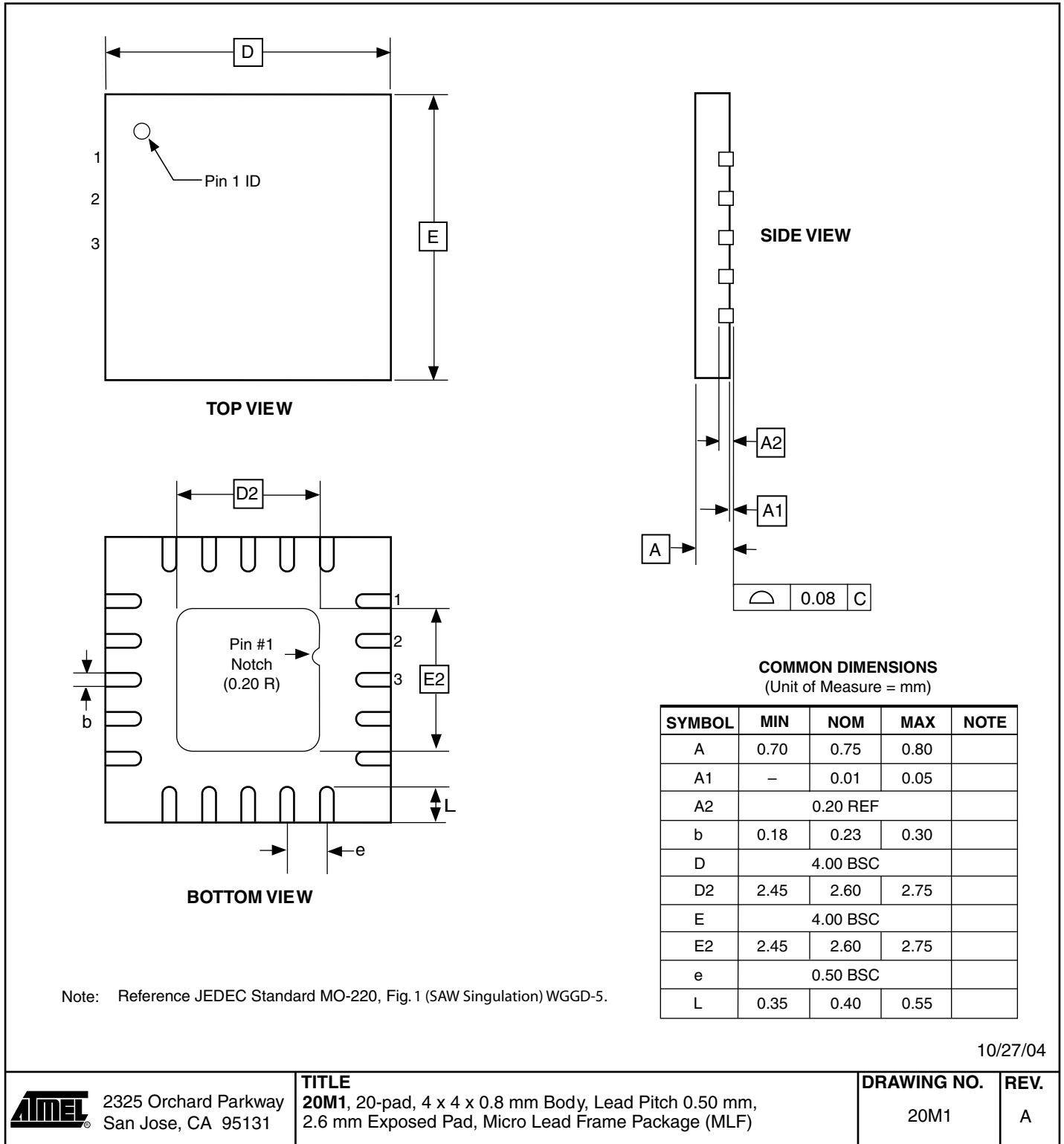

## 8. Errata

### 8.1 Errata ATtiny25

The revision letter in this section refers to the revision of the ATtiny25 device.

#### 8.1.1 Rev D and E

No known errata.

#### 8.1.2 Rev B and C

- **EEPROM read may fail at low supply voltage / low clock frequency**

##### 1. **EEPROM read may fail at low supply voltage / low clock frequency**

Trying to read EEPROM at low clock frequencies and/or low supply voltage may result in invalid data.

##### **Problem Fix/Workaround**

Do not use the EEPROM when clock frequency is below 1MHz and supply voltage is below 2V. If operating frequency can not be raised above 1MHz then supply voltage should be more than 2V. Similarly, if supply voltage can not be raised above 2V then operating frequency should be more than 1MHz.

This feature is known to be temperature dependent but it has not been characterised. Guidelines are given for room temperature, only.

#### 8.1.3 Rev A

Not sampled.

### 8.2 Errata ATtiny45

The revision letter in this section refers to the revision of the ATtiny45 device.

#### 8.2.1 Rev F and G

No known errata

#### 8.2.2 Rev D and E

- **EEPROM read may fail at low supply voltage / low clock frequency**

##### 1. **EEPROM read may fail at low supply voltage / low clock frequency**

Trying to read EEPROM at low clock frequencies and/or low supply voltage may result in invalid data.

##### **Problem Fix/Workaround**

Do not use the EEPROM when clock frequency is below 1MHz and supply voltage is below 2V. If operating frequency can not be raised above 1MHz then supply voltage should be more than 2V. Similarly, if supply voltage can not be raised above 2V then operating frequency should be more than 1MHz.

This feature is known to be temperature dependent but it has not been characterised. Guidelines are given for room temperature, only.

### 8.2.3 Rev B and C

- **PLL not locking**
- **EEPROM read from application code does not work in Lock Bit Mode 3**
- **EEPROM read may fail at low supply voltage / low clock frequency**
- **Timer Counter 1 PWM output generation on OC1B- XOC1B does not work correctly**

#### 1. **PLL not locking**

When at frequencies below 6.0 MHz, the PLL will not lock

##### **Problem fix / Workaround**

When using the PLL, run at 6.0 MHz or higher.

#### 2. **EEPROM read from application code does not work in Lock Bit Mode 3**

When the Memory Lock Bits LB2 and LB1 are programmed to mode 3, EEPROM read does not work from the application code.

##### **Problem Fix/Work around**

Do not set Lock Bit Protection Mode 3 when the application code needs to read from EEPROM.

#### 3. **EEPROM read may fail at low supply voltage / low clock frequency**

Trying to read EEPROM at low clock frequencies and/or low supply voltage may result in invalid data.

##### **Problem Fix/Workaround**

Do not use the EEPROM when clock frequency is below 1MHz and supply voltage is below 2V. If operating frequency can not be raised above 1MHz then supply voltage should be more than 2V. Similarly, if supply voltage can not be raised above 2V then operating frequency should be more than 1MHz.

This feature is known to be temperature dependent but it has not been characterised. Guidelines are given for room temperature, only.

#### 4. **Timer Counter 1 PWM output generation on OC1B – XOC1B does not work correctly**

Timer Counter1 PWM output OC1B-XOC1B does not work correctly. Only in the case when the control bits, COM1B1 and COM1B0 are in the same mode as COM1A1 and COM1A0, respectively, the OC1B-XOC1B output works correctly.

##### **Problem Fix/Work around**

The only workaround is to use same control setting on COM1A[1:0] and COM1B[1:0] control bits, see table 14-4 in the data sheet. The problem has been fixed for Tiny45 rev D.

### 8.2.4 Rev A

- **Too high power down power consumption**
- **DebugWIRE loses communication when single stepping into interrupts**
- **PLL not locking**
- **EEPROM read from application code does not work in Lock Bit Mode 3**
- **EEPROM read may fail at low supply voltage / low clock frequency**

#### 1. **Too high power down power consumption**

Three situations will lead to a too high power down power consumption. These are:

- An external clock is selected by fuses, but the I/O PORT is still enabled as an output.

- The EEPROM is read before entering power down.
- VCC is 4.5 volts or higher.

**Problem fix / Workaround**

- When using external clock, avoid setting the clock pin as Output.
- Do not read the EEPROM if power down power consumption is important.
- Use VCC lower than 4.5 Volts.

**2. DebugWIRE loses communication when single stepping into interrupts**

When receiving an interrupt during single stepping, debugwire will lose communication.

**Problem fix / Workaround**

- When singlestepping, disable interrupts.
- When debugging interrupts, use breakpoints within the interrupt routine, and run into the interrupt.

**3. PLL not locking**

When at frequencies below 6.0 MHz, the PLL will not lock

**Problem fix / Workaround**

When using the PLL, run at 6.0 MHz or higher.

**4. EEPROM read from application code does not work in Lock Bit Mode 3**

When the Memory Lock Bits LB2 and LB1 are programmed to mode 3, EEPROM read does not work from the application code.

**Problem Fix/Work around**

Do not set Lock Bit Protection Mode 3 when the application code needs to read from EEPROM.

**5. EEPROM read may fail at low supply voltage / low clock frequency**

Trying to read EEPROM at low clock frequencies and/or low supply voltage may result in invalid data.

**Problem Fix/Workaround**

Do not use the EEPROM when clock frequency is below 1MHz and supply voltage is below 2V. If operating frequency can not be raised above 1MHz then supply voltage should be more than 2V. Similarly, if supply voltage can not be raised above 2V then operating frequency should be more than 1MHz.

This feature is known to be temperature dependent but it has not been characterised. Guidelines are given for room temperature, only.

## 8.3 Errata ATtiny85

The revision letter in this section refers to the revision of the ATtiny85 device.

### 8.3.1 Rev B and C

No known errata.

### 8.3.2 Rev A

- **EEPROM read may fail at low supply voltage / low clock frequency**

#### 1. **EEPROM read may fail at low supply voltage / low clock frequency**

Trying to read EEPROM at low clock frequencies and/or low supply voltage may result in invalid data.

##### **Problem Fix/Workaround**

Do not use the EEPROM when clock frequency is below 1MHz and supply voltage is below 2V. If operating frequency can not be raised above 1MHz then supply voltage should be more than 2V. Similarly, if supply voltage can not be raised above 2V then operating frequency should be more than 1MHz.

This feature is known to be temperature dependent but it has not been characterised. Guidelines are given for room temperature, only.

## 9. Datasheet Revision History

### 9.1 Rev. 2586N-04/11

1. Added:
  - Section “Capacitive Touch Sensing” on page 6.
2. Updated:
  - Document template.
  - Removed “Preliminary” on front page. All devices now final and in production.
  - Section “Limitations” on page 37.
  - Program example on page 51.
  - Section “Overview” on page 126.
  - Table 17-4 on page 139.
  - Section “Limitations of debugWIRE” on page 144.
  - Section “Serial Programming Algorithm” on page 156.
  - Table 21-7 on page 171.
  - EEPROM errata on pages 217, 217, 218, 219, and 220
  - Ordering information on pages 209, 210, and 211.

### 9.2 Rev. 2586M-07/10

1. Clarified Section 6.4 “Clock Output Buffer” on page 32.
2. Added Ordering Codes -SN and -SNR for ATtiny25 extended temperature.

### 9.3 Rev. 2586L-06/10

1. Added:
  - TSSOP for ATtiny45 in “Features” on page 1, Pinout Figure 1-1 on page 2, Ordering Information in Section 25.2 “ATtiny45” on page 210, and Packaging Information in Section 26.4 “8X” on page 215
  - Table 6-11, “Capacitance of Low-Frequency Crystal Oscillator,” on page 29
  - Figure 22-36 on page 196 and Figure 22-37 on page 196, Typical Characteristics plots for Bandgap Voltage vs.  $V_{CC}$  and Temperature
  - Extended temperature in Section 25.1 “ATtiny25” on page 209, Ordering Information
  - Tape & reel part numbers in Ordering Information, in Section 25.1 “ATtiny25” on page 209 and Section 25.2 “ATtiny45” on page 210
2. Updated:
  - “Features” on page 1, removed Preliminary from ATtiny25
  - Section 8.4.2 “Code Example” on page 46
  - “PCMSK – Pin Change Mask Register” on page 54, Bit Descriptions
  - “TCCR1 – Timer/Counter1 Control Register” on page 92 and “GTCCR – General Timer/Counter1 Control Register” on page 93, COM bit descriptions clarified
  - Section 20.3.2 “Calibration Bytes” on page 154, frequencies (8 MHz, 6.4 MHz)
  - Table 20-11, “Minimum Wait Delay Before Writing the Next Flash or EEPROM Location,” on page 157, value for  $t_{WD\_ERASE}$

- Table 20-16, “High-voltage Serial Programming Instruction Set for ATtiny25/45/85,” on page 163
- Table 21-1, “DC Characteristics.  $T_A = -40^{\circ}\text{C}$  to  $+85^{\circ}\text{C}$ ,” on page 166, notes adjusted
- Table 21-11, “Serial Programming Characteristics,  $T_A = -40^{\circ}\text{C}$  to  $+85^{\circ}\text{C}$ ,  $V_{CC} = 1.8 - 5.5\text{V}$  (Unless Otherwise Noted),” on page 175, added  $t_{SLIV}$
- Bit syntax throughout the datasheet, e.g. from CS02:0 to CS0[2:0].

## 9.4 Rev. 2586K-01/08

1. Updated Document Template.
2. Added Sections:
  - “Data Retention” on page 6
  - “Low Level Interrupt” on page 51
  - “Device Signature Imprint Table” on page 153
3. Updated Sections:
  - “Internal PLL for Fast Peripheral Clock Generation - clkPCK” on page 24
  - “System Clock and Clock Options” on page 23
  - “Internal PLL in ATtiny15 Compatibility Mode” on page 24
  - “Sleep Modes” on page 35
  - “Software BOD Disable” on page 36
  - “External Interrupts” on page 51
  - “Timer/Counter1 in PWM Mode” on page 101
  - “USI – Universal Serial Interface” on page 111
  - “Temperature Measurement” on page 137
  - “Reading Lock, Fuse and Signature Data from Software” on page 147
  - “Program And Data Memory Lock Bits” on page 151
  - “Fuse Bytes” on page 152
  - “Signature Bytes” on page 154
  - “Calibration Bytes” on page 154
  - “System and Reset Characteristics” on page 170
4. Added Figures:
  - “Reset Pin Output Voltage vs. Sink Current ( $V_{CC} = 3\text{V}$ )” on page 189
  - “Reset Pin Output Voltage vs. Sink Current ( $V_{CC} = 5\text{V}$ )” on page 190
  - “Reset Pin Output Voltage vs. Source Current ( $V_{CC} = 3\text{V}$ )” on page 190
  - “Reset Pin Output Voltage vs. Source Current ( $V_{CC} = 5\text{V}$ )” on page 191
5. Updated Figure:
  - “Reset Logic” on page 41
6. Updated Tables:
  - “Start-up Times for Internal Calibrated RC Oscillator Clock” on page 28
  - “Start-up Times for Internal Calibrated RC Oscillator Clock (in ATtiny15 Mode)” on page 28
  - “Start-up Times for the 128 kHz Internal Oscillator” on page 29
  - “Compare Mode Select in PWM Mode” on page 89



- “Compare Mode Select in PWM Mode” on page 101
- “DC Characteristics.  $T_A = -40^{\circ}\text{C}$  to  $+85^{\circ}\text{C}$ ” on page 166
- “Calibration Accuracy of Internal RC Oscillator” on page 169
- “ADC Characteristics” on page 172
- 7. Updated Code Example in Section:
  - “Write” on page 17
- 8. Updated Bit Descriptions in:
  - “MCUCR – MCU Control Register” on page 38
  - “Bits 7:6 – COM0A[1:0]: Compare Match Output A Mode” on page 80
  - “Bits 5:4 – COM0B[1:0]: Compare Match Output B Mode” on page 80
  - “Bits 2:0 – ADTS[2:0]: ADC Auto Trigger Source” on page 142
  - “SPMCSR – Store Program Memory Control and Status Register” on page 149.
- 9. Updated description of feature “EEPROM read may fail at low supply voltage / low clock frequency” in Sections:
  - “Errata ATtiny25” on page 217
  - “Errata ATtiny45” on page 217
  - “Errata ATtiny85” on page 220
- 10. Updated Package Description in Sections:
  - “ATtiny25” on page 209
  - “ATtiny45” on page 210
  - “ATtiny85” on page 211
- 11. Updated Package Drawing:
  - “S8S1” on page 214
- 12. Updated Order Codes for:
  - “ATtiny25” on page 209

## 9.5 Rev. 2586J-12/06

1. Updated “Low Power Consumption” on page 1.
2. Updated description of instruction length in “Architectural Overview”.
3. Updated Flash size in “In-System Re-programmable Flash Program Memory” on page 15.
4. Updated cross-references in sections “Atomic Byte Programming”, “Erase” and “Write”, starting on page 17.
5. Updated “Atomic Byte Programming” on page 17.
6. Updated “Internal PLL for Fast Peripheral Clock Generation - clkPCK” on page 24.
7. Replaced single clocking system figure with two: Figure 6-2 and Figure 6-3.
8. Updated Table 6-1 on page 25, Table 6-13 on page 30 and Table 6-6 on page 28.
9. Updated “Calibrated Internal Oscillator” on page 27.
10. Updated Table 6-5 on page 27.
11. Updated “OSCCAL – Oscillator Calibration Register” on page 32.
12. Updated “CLKPR – Clock Prescale Register” on page 33.
13. Updated “Power-down Mode” on page 36.

14. Updated “Bit 0” in “PRR – Power Reduction Register” on page 39.
15. Added footnote to [Table 8-3](#) on page 48.
16. Updated [Table 10-5](#) on page 65.
17. Deleted “Bits 7, 2” in “MCUCR – MCU Control Register” on page 66.
18. Updated and moved section “Timer/Counter0 Prescaler and Clock Sources”, now located on [page 68](#).
19. Updated “Timer/Counter1 Initialization for Asynchronous Mode” on page 89.
20. Updated bit description in “PLLCSR – PLL Control and Status Register” on page 97 and “PLLCSR – PLL Control and Status Register” on page 107.
21. Added recommended maximum frequency in “Prescaling and Conversion Timing” on [page 129](#).
22. Updated [Figure 17-8](#) on page 133 .
23. Updated “Temperature Measurement” on page 137.
24. Updated [Table 17-3](#) on page 138.
25. Updated bit R/W descriptions in:
  - “TIMSK – Timer/Counter Interrupt Mask Register” on page 84,
  - “TIFR – Timer/Counter Interrupt Flag Register” on page 84,
  - “TIMSK – Timer/Counter Interrupt Mask Register” on page 95,
  - “TIFR – Timer/Counter Interrupt Flag Register” on page 96,
  - “PLLCSR – PLL Control and Status Register” on page 97,
  - “TIMSK – Timer/Counter Interrupt Mask Register” on page 106,
  - “TIFR – Timer/Counter Interrupt Flag Register” on page 106,
  - “PLLCSR – PLL Control and Status Register” on page 107 and
  - “DIDR0 – Digital Input Disable Register 0” on page 142.
26. Added limitation to “Limitations of debugWIRE” on page 144.
27. Updated “DC Characteristics” on page 166.
28. Updated [Table 21-7](#) on page 171.
29. Updated [Figure 21-6](#) on page 176.
30. Updated [Table 21-12](#) on page 176.
31. Updated [Table 22-1](#) on page 182.
32. Updated [Table 22-2](#) on page 182.
33. Updated [Table 22-30](#), [Table 22-31](#) and [Table 22-32](#), starting on [page 193](#).
34. Updated [Table 22-33](#), [Table 22-34](#) and [Table 22-35](#), starting on [page 194](#).
35. Updated [Table 22-39](#) on page 197.
36. Updated [Table 22-46](#), [Table 22-47](#), [Table 22-48](#) and [Table 22-49](#).

## 9.6 Rev. 2586I-09/06

1. All Characterization data moved to “Electrical Characteristics” on page 166.
2. All Register Descriptions are gathered up in separate sections in the end of each chapter.
3. Updated [Table 11-3](#) on page 81, [Table 11-5](#) on page 82, [Table 11-6](#) on page 83 and [Table 20-4](#) on page 152.
4. Updated “Calibrated Internal Oscillator” on page 27.
5. Updated Note in [Table 7-1](#) on page 35.
6. Updated “System Control and Reset” on page 41.
7. Updated Register Description in “I/O Ports” on page 55.

8. Updated Features in “USI – Universal Serial Interface” on page 111.
9. Updated Code Example in “SPI Master Operation Example” on page 113 and “SPI Slave Operation Example” on page 114.
10. Updated “Analog Comparator Multiplexed Input” on page 123.
11. Updated Figure 17-1 on page 127.
12. Updated “Signature Bytes” on page 154.
13. Updated “Electrical Characteristics” on page 166.

**9.7 Rev. 2586H-06/06**

1. Updated “Calibrated Internal Oscillator” on page 27.
2. Updated Table 6.5.1 on page 32.
3. Added Table 21-2 on page 169.

**9.8 Rev. 2586G-05/06**

1. Updated “Internal PLL for Fast Peripheral Clock Generation - clkPCK” on page 24.
2. Updated “Default Clock Source” on page 31.
3. Updated “Low-Frequency Crystal Oscillator” on page 29.
4. Updated “Calibrated Internal Oscillator” on page 27.
5. Updated “Clock Output Buffer” on page 32.
6. Updated “Power Management and Sleep Modes” on page 35.
7. Added “Software BOD Disable” on page 36.
8. Updated Figure 16-1 on page 123.
9. Updated “Bit 6 – ACBG: Analog Comparator Bandgap Select” on page 124.
10. Added note for Table 17-2 on page 129.
11. Updated “Register Summary” on page 205.

**9.9 Rev. 2586F-04/06**

1. Updated “Digital Input Enable and Sleep Modes” on page 59.
2. Updated Table 20-16 on page 163.
3. Updated “Ordering Information” on page 209.

**9.10 Rev. 2586E-03/06**

1. Updated Features in “Analog to Digital Converter” on page 126.
2. Updated Operation in “Analog to Digital Converter” on page 126.
3. Updated Table 17-2 on page 138.
4. Updated Table 17-3 on page 138.
5. Updated “Errata” on page 217.

## 9.11 Rev. 2586D-02/06

1. Updated [Table 6-13 on page 30](#), [Table 6-10 on page 29](#), [Table 6-3 on page 26](#), [Table 6-9 on page 29](#), [Table 6-5 on page 27](#), [Table 9-1 on page 50](#), [Table 17-4 on page 139](#), [Table 20-16 on page 163](#), [Table 21-8 on page 172](#).
2. Updated ["Timer/Counter1 in PWM Mode" on page 89](#).
3. Updated text ["Bit 2 – TOV1: Timer/Counter1 Overflow Flag" on page 96](#).
4. Updated values in ["DC Characteristics" on page 166](#).
5. Updated ["Register Summary" on page 205](#).
6. Updated ["Ordering Information" on page 209](#).
7. Updated Rev B and C in ["Errata ATtiny45" on page 217](#).
8. All references to power-save mode are removed.
9. Updated Register Adresses.

## 9.12 Rev. 2586C-06/05

1. Updated ["Features" on page 1](#).
2. Updated [Figure 1-1 on page 2](#).
3. Updated Code Examples on [page 18](#) and [page 19](#).
4. Moved "Temperature Measurement" to [Section 17.12 page 137](#).
5. Updated ["Register Summary" on page 205](#).
6. Updated ["Ordering Information" on page 209](#).

## 9.13 Rev. 2586B-05/05

1. CLKI added, instances of EEMWE/EEWE renamed EEMPE/EEPE, removed some TBD.  
Removed ["Preliminary Description" from "Temperature Measurement" on page 137](#).
2. Updated ["Features" on page 1](#).
3. Updated [Figure 1-1 on page 2](#) and [Figure 8-1 on page 41](#).
4. Updated [Table 7-2 on page 39](#), [Table 10-4 on page 65](#), [Table 10-5 on page 65](#)
5. Updated ["Serial Programming Instruction set" on page 157](#).
6. Updated SPH register in ["Instruction Set Summary" on page 207](#).
7. Updated ["DC Characteristics" on page 166](#).
8. Updated ["Ordering Information" on page 209](#).
9. Updated ["Errata" on page 217](#).

## 9.14 Rev. 2586A-02/05

Initial revision.





## Headquarters

---

### **Atmel Corporation**

2325 Orchard Parkway  
San Jose, CA 95131  
USA  
Tel: (+1)(408) 441-0311  
Fax: (+1)(408) 487-2600

## International

---

### **Atmel Asia Limited**

Unit 01-5 & 16, 19F  
BEA Tower, Millennium City 5  
418 Kwun Tong Road  
Kwun Tong, Kowloon  
HONG KONG  
Tel: (+852) 2245-6100  
Fax: (+852) 2722-1369

### **Atmel Munich GmbH**

Business Campus  
Parking 4  
D-85748 Garching b. Munich  
GERMANY  
Tel: (+49) 89-31970-0  
Fax: (+49) 89-3194621

### **Atmel Japan**

9F, Tonetsu Shinkawa Bldg.  
1-24-8 Shinkawa  
Chuo-ku, Tokyo 104-0033  
JAPAN  
Tel: (+81)(3) 3523-3551  
Fax: (+81)(3) 3523-7581

## Product Contact

---

### **Web Site**

[www.atmel.com](http://www.atmel.com)

### **Technical Support**

[avr@atmel.com](mailto:avr@atmel.com)

### **Sales Contact**

[www.atmel.com/contacts](http://www.atmel.com/contacts)

### **Literature Requests**

[www.atmel.com/literature](http://www.atmel.com/literature)

---

**Disclaimer:** The information in this document is provided in connection with Atmel products. No license, express or implied, by estoppel or otherwise, to any intellectual property right is granted by this document or in connection with the sale of Atmel products. **EXCEPT AS SET FORTH IN ATMEL'S TERMS AND CONDITIONS OF SALE LOCATED ON ATMEL'S WEB SITE, ATMEL ASSUMES NO LIABILITY WHATSOEVER AND DISCLAIMS ANY EXPRESS, IMPLIED OR STATUTORY WARRANTY RELATING TO ITS PRODUCTS INCLUDING, BUT NOT LIMITED TO, THE IMPLIED WARRANTY OF MERCHANTABILITY, FITNESS FOR A PARTICULAR PURPOSE, OR NON-INFRINGEMENT. IN NO EVENT SHALL ATMEL BE LIABLE FOR ANY DIRECT, INDIRECT, CONSEQUENTIAL, PUNITIVE, SPECIAL OR INCIDENTAL DAMAGES (INCLUDING, WITHOUT LIMITATION, DAMAGES FOR LOSS OF PROFITS, BUSINESS INTERRUPTION, OR LOSS OF INFORMATION) ARISING OUT OF THE USE OR INABILITY TO USE THIS DOCUMENT, EVEN IF ATMEL HAS BEEN ADVISED OF THE POSSIBILITY OF SUCH DAMAGES.** Atmel makes no representations or warranties with respect to the accuracy or completeness of the contents of this document and reserves the right to make changes to specifications and product descriptions at any time without notice. Atmel does not make any commitment to update the information contained herein. Unless specifically provided otherwise, Atmel products are not suitable for, and shall not be used in, automotive applications. Atmel's products are not intended, authorized, or warranted for use as components in applications intended to support or sustain life.

© 2011 Atmel Corporation. All rights reserved.

Atmel®, logo and combinations thereof, and others are registered trademarks or trademarks of Atmel Corporation or its subsidiaries. Other terms and product names may be trademarks of others.