

CUSTOMER'S NAME

員亭

ALPHA REFERENCE NO.

SP08120135

SPECIFICATION

PART NO.	ALPHA MODEL NAME
1.	RV16AF-20-17K-

MODEL NAME
MODEL NO.

APPROVAL

PREPARED BY	REVIEWED BY	APPROVED BY
 吳麗君 97.12.11	 王仕維 97.12.11	 王茂松 97.12.11



台灣艾華電子工業股份有限公司

桃園市中正路1221-1223號9樓

TAIWAN ALPHA ELECTRONIC CO., LTD.

9F, NO. 1221, Chung Cheng Rd., Taoyuan, Taiwan

TEL: 886-3-3577799 FAX: 886-3-3577700

E-mail: sales@taiwanalpha.com.tw

URL: http://www.taiwanalpha.com

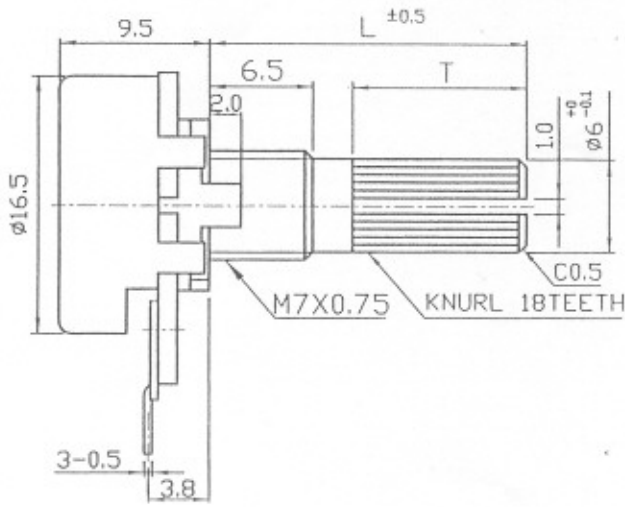

SHAFT SHAFT IN FULL C.C.W. POSITION

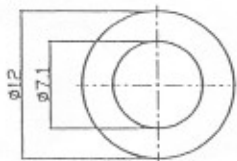
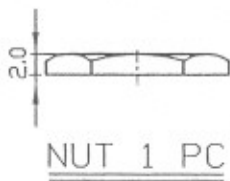
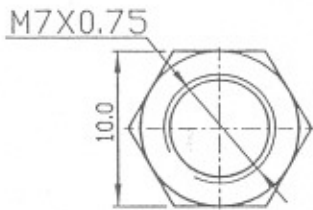
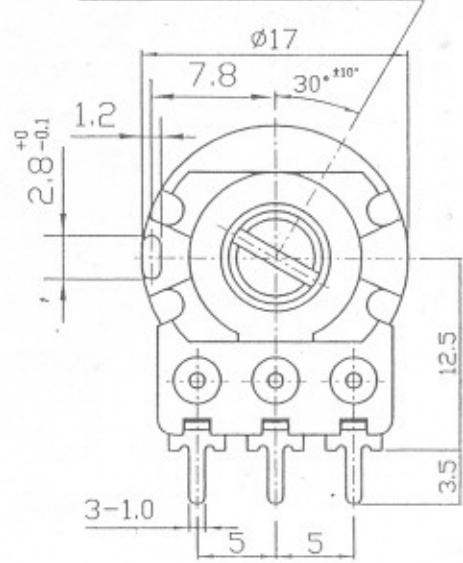

WASHER 1 PC t=0.6

MOUNTING HOLE DETAIL (VIEWPOINT OF SHAFT)

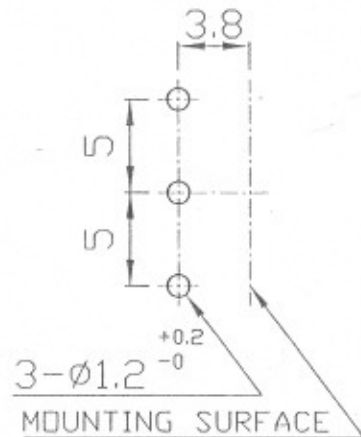

	L	T
	15	6.5
✓	17	8.5
	20	11.5

RV16AF-20-(L)K-XXX-3(3X)(3C97A)

NO.	DATE	DESCRIPTION	MODEL NAME			
TOL. UNLESS OTHERWISE STATED	DIMENSION	SCALE	DRAWN BY	CHECKED BY	APPROVED BY	DRAWING NO.
less than 10 ±0.3	mm	2 / 1	吳	王	楊	
above 10 ~ 30 ±0.5			97.5.11	200.6.11	200.6.11	
above 30 ~ 100 ±1.0			宜芬	茂松	子鑫	
above ±5'						

16E單軸單連迴轉式 VR 規格書

SPECIFICATIONS OF 16E ROTARY POTENTIOMETER

- 一、 機械規格 MECHANICAL CHARACTERISTICS :
- 1.1 全迴轉角度：300 ± 5 度
OVERALL ROTATION ANGLE : 300 ± 5°
- 1.2 迴轉轉矩：20~200gf-cm (迴轉速度 60 度 / 1 秒)
OPERATION TORQUE : 20 ~ 200gf-cm . (ROTATIONAL SPEED 60° / 1 sec)
- 1.3 起動迴轉轉矩：450gf-cm 以下
STARTING TORQUE : 450gf-cm MAX .
- 1.4 軸鬆動：固定腳焊錫後軸前端加上 500gf-cm 之力矩，於軸前端移動之
0.7 × L / 30 mm P-P 以內。
PLAY OF SHAFT : THE RESISTOR SHALL BE MOUNTED BY SOLDERING THE MOUNTING LEGS ON THE PANEL, AND AN END THRUST OF 500gf-cm AT THE END OF THE SHAFT SHALL BE APPLIED .
THEN THE TOTAL PLAY OF THE SHAFT SHALL BE NOT EXCEED 0.7 × L / 30 mm P-P .
- 1.5 軸擠壓引張強度：焊錫後擠壓，引張耐 8kg，3 秒（指施加於垂直軸之端面而言）不可有電氣或機械上的異常。
STRENGTH OF SHAFT AGAINST END THRUST :
THE SHAFT SHALL WITHSTAND AGAINST END THRUST OF NOT LESS THAN 3kgf FOR 3 SECONDS .
- 1.6 軸之迴轉止動強度：6kgf-cm 以上。
SHAFT END STOP STRENGTH : 6kgf-cm MIN .
- 1.7 軸橫擠壓強度：鐸錫後軸前端垂直方向耐 3kgf-cm，3 秒後不可有電氣或機械上的異常。（1.6，1.7 項並不包含鐸錫部位之浮起）
ROBUSTNESS OF SHAFT AGAINST SIDE THRUST :
THE SHAFT SHALL WITHSTAND AGAINST SIDE THRUST OF NOT LESS THAN 3kgf-cm FOR 3 SECONDS ON THE END OF THE SHAFT AT RIGHT ANGLES TO THE AXIS OF THE SHAFT AFTER MOUNTING THE RESISTOR BY SOLDERING .
- 1.8 鐸錫耐熱性：鐸錫後,不可發生顯著之鬆動接觸不良
RESISTANCE TO SOLDERING HEAT :
AFTER SOLDERING, THERE SHALL BE NO EVIDENCE OF POOR CONTACT BETWEEN RESISTANCE ELEMENT AND TERMINALS , OR ANY PHYSICAL DAMAGES AS A RESULT OF THE TEST .

- 1.9 軸承螺絲固定強度：7kgf-cm 以上 .
BUSHING MOUNT STRENGTH：7kgf-cm MIN .
- 1.10 CLICK 位置：150 ± 2.5°
POSITION OF CLICK：150 ± 2.5°
- 1.11 CLICK 脫出力：30~250gf-cm
TORQUE OF CLICK：30~250gf-cm
☆ (1.10, 1.11 僅適用於附 CLICK 時)
(1.10, 1.11 IS USED FOR CLICK ONLY)

二、電器規格 ELECTRICAL CHARACTERISITICS：

- 2.1 全阻值：阻值適用範圍 1KΩ~500KΩ (容許差 ± 20%)
OVERALL RESISTANCE RANGE：1KΩ~500KΩ (TOLERANCE± 20%)
- 2.2 額定功率：B 線性 0.125W . B 以外線性 0.06W
POWER RATING：B TAPER 0.125W . EXCEPT B 0.06W
- 2.3 殘留阻值：1~2 端子 / 2~3 端子同 .
RESIDUAL RESISTANCE：terminal 1~2 / 2~3

公稱阻抗值 (KΩ) OVERALL RESISTANCE (KΩ)	殘留阻值 (Ω) MAXIMUM ATTENUATION LEVEL (Ω)
R ≤ 20	10 以下 10MAX
20 < R ≤ 100	20 以下 20MAX
100 < R ≤ 1M	50 以下 50MAX

2.4 阻抗變化特性 TAPER：

阻抗變化 特性 Taper	測定角 度 Test point	端子 1-2 間輸出電壓 V_{1-2} 端子 1-3 間輸出電壓 V_{1-3} (%)	端子 2-3 間輸出電壓 V_{2-3} 端子 1-3 間輸出電壓 V_{1-3} (%)
A	150°	10-25	
B	150°	40-60	
* C	*150°		10-25
D(10A)	150°	6-15	
* E(25C)	*150°		15-35
K(25A)	150°	15-35	
W(4B)	90±5°	5-15	
	150°	40-60	
	210±5°	85-95	
M	75±5°	40-60	
	150°	98-100	
* N	*75±5°		40-60
	*150°		98-100
* X(10C)	*150°		6-15

(註) * 記號表示自第三端子測起 * WITH RESPECT TO TERMINAL 3

- 2.5 轉動雜音：依 JIS 測定法 47mV 以下 (W : 200mv 以下) .
ROTATION NOISE (REFER TO JIS) : 47mV MAX . (W : 200mV MAX) .
- 2.6 絕緣阻抗：D.C 500V 須在 100MΩ 以上
INSULATION RESISTANCE : 100MΩ MIN . AT D.C 500 VOLTS
- 2.7 耐電壓：A.C 500V 可耐 1 分鐘以上
DIELECTRIC TEST : UNITS SHALL BE DESIGNED TO WITHSTAND
500 VOLTS BETWEEN RESISTANCE ELEMENTS
AND CASE FOR A PERIOD OF ONE MINUTE
WITHOUT DAMAGE OR ARCING .
- 2.8 最高使用電壓：A.C 150V .
MAXIMUM OPERATING VOLTAGE : 150V A.C
- 三、耐久性能 ENDURANCE CHARACTERISTICS :
- 3.1 電阻體迴轉壽命特性：15,000 迴轉以上
ROTATIONAL LIFE : MORE THAN 15,000 CYCLES
- 四、其他之性能 依照 JISC 6443 普通級碳素系可變電阻器：
NOTE MEET OR EXCEED JISC 6443 REQUIREMENTS .

STANDARD RESISTANCE TAPER

B TAPER (JIS:B)

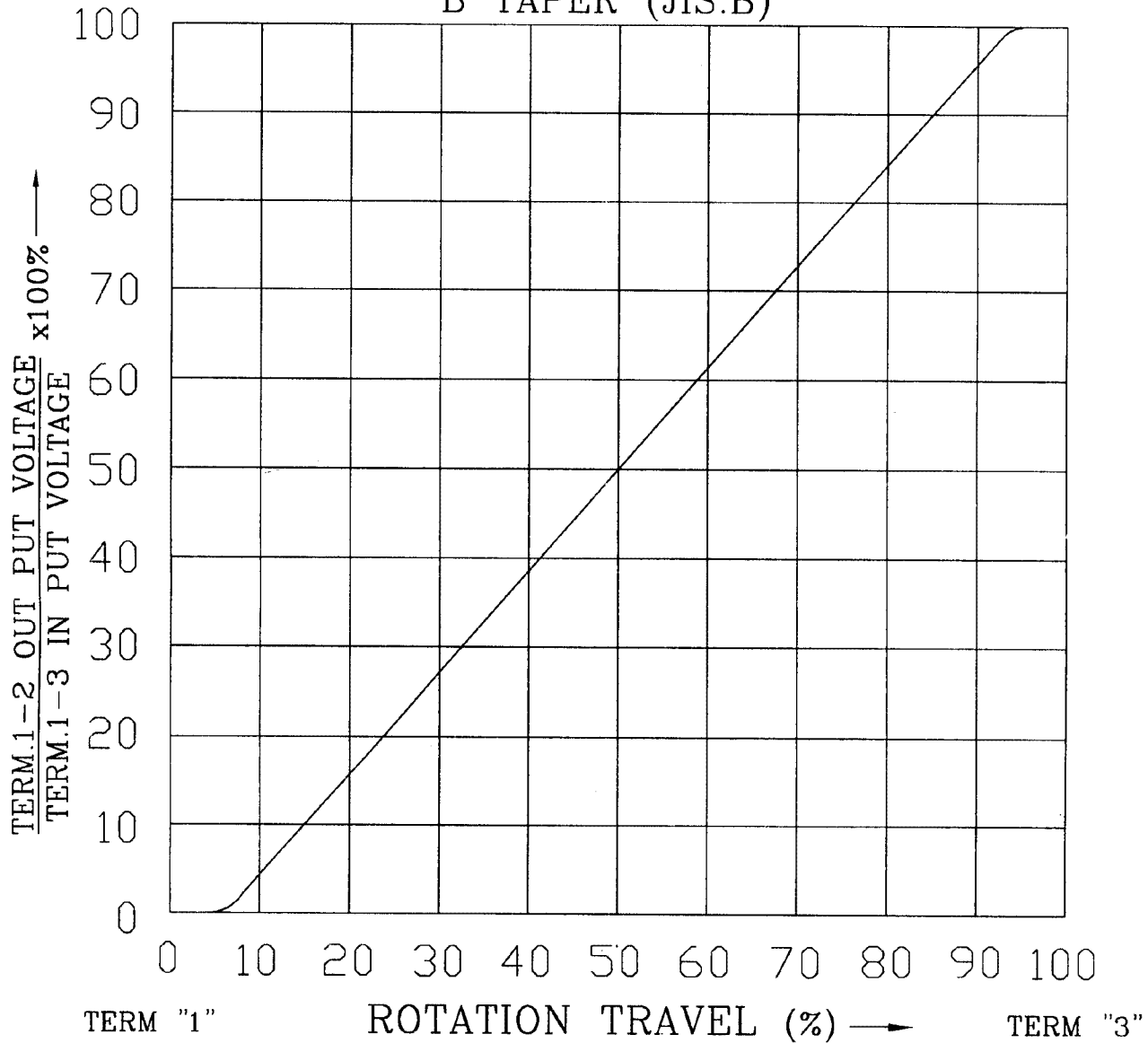

NO.	DATE	DESCRIPTION		MODEL NAME		
TOL. UNLESS OTHERWISE STATED		DIMENSION	SCALE	DRAWN BY	CHECKED BY	APPROVED BY
less than 10 ±0.3		mm		何	王	王
above 10 ~ 30 ±0.5				90.8.21	90.8.21	90.8.21
above 30 ~100 ±1.0				建志	茂松	茂松
above ±5'						
DRAWING NO.						

可變電阻無鉛焊錫共通規格書

Common Specification of Lead-Free Soldering for Potentiometers

以下焊錫條件以可變電阻置於單層 1.6mm 厚度之印刷電路板上測試為基準。

The specification below is based on testing results of 1.6mm thickness single layer printed circuit board.

1. 手工焊錫條件：

For Manual Soldering：

1-1 操作溫度最高 350°C，操作時間 3 秒以內。

To be performed within 3 seconds at 350°C or below.

2. 自動或半自動機台焊錫條件：

For Automated or Semi-Automated Soldering Equipments:

2-1 使用發泡式且比重 0.82 以上的助焊劑，發泡高度以印刷電路板厚度一半為標準，且助焊劑不能流入可變電阻基板表面及印刷電路板表面。

Flux of 0.82 specific gravity, applied by foam fluxer, shall be used. Foam head shall be limited to the height which is half thickness of printed circuit board to be soldered. No flux should be allowed to run up onto resistive element board of potentiometer and the surface of printed circuit board.

2-2 預熱時間不超過兩分鐘，焊錫界面 (即印刷電路板底) 最高預熱溫度不超過 100°C。

Regarding preheating, the entire flow duration should not exceed 2 minutes, and soldering surface temperature (undersurface of PCB) shall be settled within 100°C.

2-3 焊錫過程機台設定溫度在 260°C 以下、4 秒以內。

Solder Dipping is to be performed within 4 seconds at 260°C or below.

3. 若可變電阻為帶有檔位，請將主軸或滑柄先調整至其中一個檔位或中心檔位上才可以進行焊錫作業。

For potentiometer with centre detent or multiple detents, its shaft or lever should be settled in relevant detent position prior to soldering process.

4. 手工焊錫、自動或半自動機台焊錫不得超過一回。

Regardless of soldering facility and method, solder dipping or solder smearing must not be carried out more than 1 time.

註：本項焊錫溫度條件不適用於回流焊接作業設備。

Remarks : This specification is not recommended for and applicable in reflow soldering.